



**2022**  
CATÁLOGO

MADE IN SPAIN

Situada en Aretxabaleta. Dentro de la comarca guipuzcoana del Alto Deba. Un núcleo industrial referente con una destacada experiencia en innovación de producto y perfectamente comunicada con el resto de la península y Europa.







# experiencia y futuro

Más de 80 años en el mundo de la cerrajería nos proporcionan un control del medio, de las redes de distribución y de las necesidades del cliente. Pero sobre todo nos ha permitido entender que era el momento de dar un paso hacia adelante.

## ÍNDICE POR REFERENCIA

REF.	PÁG.	REF.	PÁG.	REF.	PÁG.	REF.	PÁG.
1122A70D/0	102	122A70D/1	102	156B60I/0	97	194/30/6	40
1122A70D/1	102	122A70I/0	102	156B60I/1	97	194/30/6AN	40
1122A70I/0	102	122A70I/1	102	156BR70D/0	97	194/30/6U	40
1122A70I/1	102	122C70D/0	103	156BR70D/1	97	194/35/6	40
1122C70D/0	103	122C70D/1	103	156BR70I/0	97	194/35/6AN	40
1122C70D/1	103	122C70I/0	103	156BR70I/1	97	194/35/6U	40
1122C70I/0	103	122C70I/1	103	156C60D/0	98	194F/30/6	41
1122C70I/1	103	123A10D/0	104	156C60D/1	98	194F/35/6	41
1123A10D/0	104	123A10D/1	104	156C60I/0	98	194RV25/6	40
1123A10D/1	104	123A10I/0	104	156C60I/1	98	194RV25/6AN	40
1123A10I/0	104	123A10I/1	104	156C70D/0	98	194RV25/6U	40
1123A10I/1	104	123A12D/0	104	156C70D/1	98	194RV30/6	40
1123A12D/0	104	123A12D/1	104	156C70I/0	98	194RV30/6AN	40
1123A12D/1	104	123A12I/0	104	156C70I/1	98	194RV30/6U	40
1123A12I/0	104	123A12I/1	104	184/21/0	30	194RV35/6	40
1123A12I/1	104	123C10D/0	105	184/21/6D	30	194RV35/6AN	40
1123C10D/0	105	123C10D/1	105	184/23/0	30	194RV35/6U	40
1123C10D/1	105	123C10I/0	105	184/23/6	30	196/25/6	34
1123C10I/0	105	123C10I/1	105	184/25/0	30	196/25/6AN	34
1123C10I/1	105	123C12D/0	105	184/25/6	30	196/28/6	34
1123C12D/0	105	123C12D/1	105	184/28/0	30	196/28/6AN	34
1123C12D/1	105	123C12I/0	105	184/28/6	30	196/30/6	34
1123C12I/0	105	123C12I/1	105	184/30/0	30	196/30/6AN	34
1123C12I/1	105	124A10D/0	101	184/30/6	30	196/33/6	34
1124A10D/0	101	124A10D/1	101	184/33/0	30	196/33/6AN	34
1124A10D/1	101	124A10I/0	101	184/33/6	30	196/35/6	34
1124A10I/0	101	124A10I/1	101	184/35/0	30	196/35/6AN	34
1124A10I/1	101	124A12D/0	101	184/35/6	30	196/38/6	34
1124A12D/0	101	124A12D/1	101	184A23/6	30	196/38/6AN	34
1124A12D/1	101	124A12I/0	101	184A25/6	30	1960/60/2	117
1124A12I/0	101	124A12I/1	101	184A28/6	30	1960/60/6	117
1124A12I/1	101	124A14D/0	101	184A30/6	30	1960/70/2	117
1124A14D/0	101	124A14D/1	101	184A33/6	30	1960/70/6	117
1124A14D/1	101	124A14I/0	101	184A35/6	30	1960A60/2	117
1124A14I/0	101	124A14I/1	101	184V23/6	31	1960A60/6	117
1124A14I/1	101	124A8D/0	101	184V25/6	31	1960A70/2	117
1124A8D/0	101	124A8D/1	101	184V28/6	31	1960A70/6	117
1124A8D/1	101	124A8I/0	101	184V30/6	31	1960T60/2	117
1124A8I/0	101	124A8I/1	101	184V33/6	31	1960T60/6	117
1124A8I/1	101	125A12D/0	99	184V35/6	31	1960T70/2	117
1125A12D/0	99	125A12D/1	99	190/23/0	67	1960T70/6	117
1125A12D/1	99	125A12I/0	99	190/23/5	67	1961/60/2	118
1125A12I/0	99	125A12I/1	99	190/23/6	67	1961/70/2	118
1125A12I/1	99	125A14D/0	99	190/28/0	67	1961A60/2	118
1125A14D/0	99	125A14D/1	99	190/28/5	67	1961A70/2	118
1125A14D/1	99	125A14I/0	99	190/28/6	67	1962/60/2	119
1125A14I/0	99	125A14I/1	99	190/33/0	67	1962/70/2	119
1125A14I/1	99	125A8D/0	99	190/33/5	67	1962A60/2	119
1125A8D/0	99	125A8D/1	99	190/33/6	67	1962A70/2	119
1125A8D/1	99	125A8I/0	99	190A23/0	67	1962T60/2	119
1125A8I/0	99	125A8I/1	99	190A23/5	67	1962T70/2	119
1125A8I/1	99	125AR10D/0	99	190A23/6	67	1963/0	78
1125AR10D/0	99	125AR10D/1	99	190A28/0	67	1963/5	78
1125AR10D/1	99	125AR10I/0	99	190A28/5	67	1963/6	78
1125AR10I/0	99	125AR10I/1	99	190A28/6	67	1963A/0	78
1125AR10I/1	99	125BR12D/0	100	190A33/0	67	1963A/5	78
1125BR12D/0	100	125BR12D/1	100	190A33/5	67	1963A/6	78
1125BR12D/1	100	125BR12I/0	100	190A33/6	67	1963C/6	78
1125BR12I/0	100	125BR12I/1	100	192/25/6	37	1963CP16/6	79
1125BR12I/1	100	125BR14D/0	100	192/25/6AN	37	1963R/0	79
1125BR14D/0	100	125BR14D/1	100	192/30/6	37	1963RV/0	79
1125BR14D/1	100	125BR14I/0	100	192/30/6AN	37	1963V/0	79
1125BR14I/0	100	125BR14I/1	100	192/35/6	37	1963V/5	79
1125BR14I/1	100	156A60D/0	96	192/35/6AN	37	1963V/6	79
11981/60/0	83	156A60D/1	96	192V25/6	37	1964/0	81
11981/60/5	83	156A60I/0	96	192V25/6AN	37	1964/5	81
11981V60/0	83	156A60I/1	96	192V30/6	37	1964/6	81
11981V60/5	83	156A70D/0	96	192V30/6AN	37	1964A/0	81
11A	88	156A70D/1	96	192V35/6	37	1964A/5	81
11A/3P	88	156A70I/0	96	192V35/6AN	37	1964C/0	81
11B	89	156A70I/1	96	194/25/6	40	1964C/6	81
11B/M	89	156B60D/0	97	194/25/6AN	40	1964CP/6	81
122A70D/0	102	156B60D/1	97	194/25/6U	40	1964R/0	82

**ÍNDICE POR REFERENCIA**

REF.	PÁG.	REF.	PÁG.	REF.	PÁG.	REF.	PÁG.
1964RV/0	82	1978/1	107	1990/25/0	68	1E2/50/6U	18
1964T/0	82	1979/0	87	1990/25/5	68	1E2NV/30/6	19
1964T/5	82	1979/5	87	1990/25/6	68	1E2NV/30/6AN	19
1964T/6	82	1979P/0	87	1990/32/0	68	1E2NV/30/6U	19
1964V/0	82	1979P/5	87	1990/32/5	68	1E2NV/35/6	19
1964V/5	82	197KBN25/6U16	60	1990/32/6	68	1E2NV/35/6AN	19
1964V/6	82	1981/60/0	83	1990A20/0	68	1E2NV/35/6U	19
1968/0	85	1981/60/5	83	1990A20/5	68	1E2NV/40/6	19
1968/5	86	1981V60/0	83	1990A20/6	68	1E2NV/40/6AN	19
196A25/6	34	1981V60/5	83	1990A25/0	68	1E2NV/40/6U	19
196A28/6	34	1982/0	86	1990A25/5	68	1E2NV/45/6	19
196A30/6	34	1982/5	88	1990A25/6	68	1E2NV/45/6AN	19
196A33/6	34	1983/20/0	76	1990A32/0	68	1E2NV/45/6U	19
196A35/6	34	1983/20/5	76	1990A32/5	68	1E2NV/50/6	19
196A38/6	34	1983/20/6	76	1990A32/6	68	1E2NV/50/6AN	19
196R23/6	35	1983/25/0	76	1990V20/0	68	1E2NV/50/6U	19
196R25/6	35	1983/25/5	76	1990V20/5	68	1E5/30/6	21
196R28/6	35	1983/25/6	76	1990V20/6	68	1E5/30/6AN	21
196R30/6	35	1983/30/0	76	1990V25/0	68	1E5/30/6U	21
196R33/6	35	1983/30/5	76	1990V25/5	68	1E5/35/6	21
196R35/6	35	1983/30/6	76	1990V25/6	68	1E5/35/6AN	21
196R38/6	35	1983A20/0	76	1990V32/0	68	1E5/35/6U	21
196RV/6	35	1983A20/5	76	1990V32/5	68	1E5/40/6	21
196T23/6	35	1983A25/0	76	1990V32/6	68	1E5/40/6AN	21
196T25/6	35	1983A25/5	76	1991/60/0	84	1E5/40/6U	21
196T28/6	35	1983A30/0	76	1991/60/5	84	1E5/45/6	21
196T30/6	35	1983A30/5	76	1991/70/0	84	1E5/45/6AN	21
196T33/6	35	1983R20/0	76	1991/70/5	84	1E5/45/6U	21
196T35/6	35	1983R25/0	76	1992/20/6	75	1E5/50/6	21
196T38/6	35	1983R30/0	76	1992/25/6	75	1E5/50/6AN	21
196V25/6	35	1983RV/0	77	1992/30/6	75	1E5/50/6U	21
196V28/6	35	1983T20/6	77	1992T20/6	75	115K25/6U16	58
196V30/6	35	1983T25/6	77	1992T25/6	75	1K5/30/6	23
196V33/6	35	1983T30/6	77	1992T30/6	75	1K5/33/6	23
196V35/6	35	1984/20/0	64	1994/25/6L	69	1K5/35/6	23
196V38/6	35	1984/20/5	64	1994/25/6U	69	1K5T30/6	23
197/25/6	36	1984/20/6	64	1994/30/6L	69	1K5T33/6	23
197/28/6	36	1984/25/0	64	1994/30/6U	69	1K5T35/6	23
197/30/6	36	1984/25/5	64	1994/35/6L	69	1T8KD20/6L17B	62
197/33/6	36	1984/25/6	64	1994/35/6U	69	1T8KD20/6L17N	62
197/35/6	36	1984/30/0	64	1994A25/6L	70	1T8KD20/6LB	62
197/38/6	36	1984/30/5	64	1994A25/6U	70	1T8KD20/6LN	62
1970N/40/2	115	1984/30/6	64	1994A30/6L	70	234/50/1	109
1970N/40/6	115	1984T20/6	64	1994A30/6U	70	234/60/1	109
1970N/50/2	115	1984T25/6	64	1994A35/6L	70	234/70/1	109
1970N/50/6	115	1984T30/6	64	1994A35/6U	70	236/50/1	110
1970N/60/2	115	1984V20/6	64	1994V25/6L	70	236/60/1	110
1970N/60/6	115	1984V25/6	64	1994V25/6U	70	236/70/1	110
1970NA40/2	115	1984V30/6	64	1994V30/6L	70	249B50/2	120
1970NA40/6	115	1985N/40/2	114	1994V30/6U	70	249B60/2	120
1970NA50/2	115	1985N/40/6	114	1994V35/6L	70	249B70/2	120
1970NA50/6	115	1985N/50/2	114	1994V35/6U	70	249R50/2	120
1970NA60/2	115	1985N/50/6	114	1995/32/0	65	249R60/2	120
1970NA60/6	115	1985N/60/2	114	1995/32/5	65	249R70/2	120
1970NT40/2	115	1985N/60/6	114	1995/32/6	65	294N/30/6L	38
1970NT40/6	115	1985NT40/2	114	1995A32/6	65	294N/30/6LAN	38
1970NT50/2	115	1985NT40/6	114	1995R32/0	65	294N/30/6U	38
1970NT50/6	115	1985NT50/2	114	1995T32/6	66	294N/35/6L	38
1970NT60/2	115	1985NT50/6	114	1995V32/6	66	294N/35/6LAN	38
1970NT60/6	115	1985NT60/2	114	1E2/30/6	18	294N/35/6U	38
1970NV40/6	116	1985NT60/6	114	1E2/30/6AN	18	294NV30/6L	39
1970NV50/6	116	1988/0	108	1E2/30/6U	18	294NV30/6LAN	39
1970NV60/6	116	1988/1	108	1E2/35/6	18	294NV30/6U	39
1975/0	80	198K25/6	61	1E2/35/6AN	18	294NV35/6L	39
1975/5	80	198K30/6	61	1E2/35/6U	18	294NV35/6LAN	39
1975A/0	80	198K35/6	61	1E2/40/6	18	294NV35/6U	39
1975A/5	80	198KB25/6	61	1E2/40/6AN	18	296/25/6L	32
1975T/0	80	198KB30/6	61	1E2/40/6U	18	296/25/6LAN	32
1975T/5	80	198KB35/6	61	1E2/45/6	18	296/25/6U	32
1975V/0	80	198KD20/6	61	1E2/45/6AN	18	296/28/6L	32
1975V/5	80	1990/20/0	68	1E2/45/6U	18	296/28/6LAN	32
1976/1	106	1990/20/5	68	1E2/50/6	18	296/28/6U	32
1978/0	107	1990/20/6	68	1E2/50/6AN	18	296/30/6L	32

## ÍNDICE POR REFERENCIA

REF.	PÁG.	REF.	PÁG.	REF.	PÁG.	REF.	PÁG.
296/30/6LAN	32	2E2/30/6U	16	2I2/55/6L	26	4001/50/0	112
296/30/6U	32	2E2/35/6L	16	2I2/55/6LAN	26	4001/50/6	112
296/33/6L	32	2E2/35/6LAN	16	2I2/55/6U	26	4001/60/0	112
296/33/6LAN	32	2E2/35/6U	16	2I2GB30/6L	25	4001/60/6	112
296/33/6U	32	2E2/40/6L	16	2I2GB30/6LAN	25	4001A50/0	112
296/35/6L	32	2E2/40/6LAN	16	2I2GB30/6U	25	4001A50/6	112
296/35/6LAN	32	2E2/40/6U	16	2I2GB33/6L	25	4001A60/0	112
296/35/6U	32	2E2/45/6L	16	2I2GB33/6LAN	25	4001A60/6	112
296/38/6L	32	2E2/45/6LAN	16	2I2GB33/6U	25	400L60/6HP	154
296/38/6LAN	32	2E2/45/6U	16	2I2GB35/6L	25	400LT60/6H	155
296A25/6L	33	2E2/50/6L	16	2I2GB35/6LAN	25	400T50/6H	155
296A25/6LAN	33	2E2/50/6LAN	16	2I2GB35/6U	25	400T60/6H	155
296A25/6U	33	2E2/50/6U	16	2I2GB38/6L	25	410/50/6HP	158
296A28/6L	33	2E2GB30/6L	15	2I2GB38/6LAN	25	410/50D/6HP	157
296A28/6LAN	33	2E2GB30/6LAN	15	2I2GB38/6U	25	410/50I/6HP	157
296A30/6L	33	2E2GB30/6U	15	2I2GB45/6L	25	410/60/6HP	158
296A30/6LAN	33	2E2GB35/6L	15	2I2GB45/6LAN	25	410/60D/6HP	157
296A30/6U	33	2E2GB35/6LAN	15	2I2GB45/6U	25	410/60I/6HP	157
296A33/6L	33	2E2GB35/6U	15	2I2GB55/6L	25	4100/50/0	113
296A33/6LAN	33	2E2GB40/6L	15	2I2GB55/6LAN	25	4100/60/0	113
296A35/6L	33	2E2GB40/6LAN	15	2I2GB55/6U	25	410L60/6HP	157
296A35/6LAN	33	2E2GB40/6U	15	2I5K25/6U16	57	410L60D/6HP	156
296A35/6U	33	2E2GB45/6L	15	2I5K825/6U16	57	410L60I/6HP	156
296A38/6L	33	2E2GB45/6LAN	15	2K5/30/6L	22	4E25/30/6L	14
296A38/6LAN	33	2E2GB45/6U	15	2K5/33/6L	22	4E25/35/6L	14
296V25/6L	33	2E2GB50/6L	15	2K5/35/6L	22	4E25/40/6L	14
296V25/6LAN	33	2E2GB50/6LAN	15	3994/25/6L	73	4E25/45/6L	14
296V25/6U	33	2E2GB50/6U	15	3994/25/6U	73	4E25/50/6L	14
296V28/6L	33	2E2NV/30/6L	17	3994/30/6L	73	4I25/30/6L	24
296V28/6LAN	33	2E2NV/30/6LAN	17	3994/30/6U	73	4I25/33/6L	24
296V30/6L	33	2E2NV/30/6U	17	3994/35/6L	73	4I25/35/6L	24
296V30/6LAN	33	2E2NV/35/6L	17	3994/35/6U	73	4I25/38/6L	24
296V30/6U	33	2E2NV/35/6LAN	17	3994A25/6L	73	4I25/45/6L	24
296V33/6L	33	2E2NV/35/6U	17	3994A25/6U	73	4I25/55/6L	24
296V33/6LAN	33	2E2NV/40/6L	17	3994A30/6L	73	4I54K256U16	56
296V35/6L	33	2E2NV/40/6LAN	17	3994A30/6U	73	4I54K8256U16	56
296V35/6LAN	33	2E2NV/40/6U	17	3994A35/6L	73	5000/1N	149
296V35/6U	33	2E2NV/45/6L	17	3994A35/6U	73	5000/1NM	149
296V38/6L	33	2E2NV/45/6LAN	17	3994F25/6L	74	5000/6	149
296V38/6LAN	33	2E2NV/45/6U	17	3994F25/6U	74	5081/3030/3	141
297KN25/6U16	59	2E2NV/50/6L	17	3994F30/6L	74	5081/3030/4	141
2994/25/6L	71	2E2NV/50/6LAN	17	3994F30/6U	74	5181/3030/3	141
2994/25/6U	71	2E2NV/50/6U	17	3994F35/6L	74	5181/3030/4	141
2994/30/6L	71	2E5/30/6L	20	3994F35/6U	74	5500/1N	150
2994/30/6U	71	2E5/30/6LAN	20	3994V25/6L	74	5500/1NM	150
2994/35/6L	71	2E5/30/6U	20	3994V25/6U	74	5500/6	150
2994/35/6U	71	2E5/35/6L	20	3994V30/6L	74	56A60D/0	96
2994A25/6L	72	2E5/35/6LAN	20	3994V30/6U	74	56A60D/1	96
2994A25/6U	72	2E5/35/6U	20	3994V35/6L	74	56A60I/0	96
2994A30/6L	72	2E5/40/6L	20	3994V35/6U	74	56A60I/1	96
2994A30/6U	72	2E5/40/6LAN	20	3I2/30/6L	27	56A70D/0	96
2994A35/6L	72	2E5/40/6U	20	3I2/33/6L	27	56A70D/1	96
2994A35/6U	72	2E5/45/6L	20	3I2/35/6L	27	56A70I/0	96
2994V25/6L	72	2E5/45/6LAN	20	3I2/38/6L	27	56A70I/1	96
2994V25/6U	72	2E5/45/6U	20	3I2/45/6L	27	56B60D/0	97
2994V30/6L	72	2E5/50/6L	20	3I2/55/6L	27	56B60D/1	97
2994V30/6U	72	2E5/50/6LAN	20	3I2F45/6L	27	56B60I/0	97
2994V35/6L	72	2E5/50/6U	20	3I5/30/6L	27	56B60I/1	97
2994V35/6U	72	2I2/30/6L	26	3I5/33/6L	27	56BR70D/0	97
2A2/30/6L	13	2I2/30/6LAN	26	3I5/35/6L	27	56BR70D/1	97
2A2/30/6LAN	13	2I2/30/6U	26	3I5/38/6L	27	56BR70I/0	97
2A2/30/6U	13	2I2/33/6L	26	3I5/45/6L	27	56BR70I/1	97
2A2/35/6L	13	2I2/33/6LAN	26	3I5/55/6L	27	56C60D/0	98
2A2/35/6LAN	13	2I2/33/6U	26	400/50/6HP	154	56C60D/1	98
2A2/35/6U	13	2I2/35/6L	26	400/60/6HP	154	56C60I/0	98
2A2/45/6L	13	2I2/35/6LAN	26	4000/50/0	112	56C60I/1	98
2A2/45/6LAN	13	2I2/35/6U	26	4000/50/6	112	56C70D/0	98
2A2/45/6U	13	2I2/38/6L	26	4000/60/0	112	56C70D/1	98
2A2M30/6L	11	2I2/38/6LAN	26	4000/60/6	112	56C70I/0	98
2A2M35/6L	11	2I2/38/6U	26	4000A50/0	112	56C70I/1	98
2A2M45/6L	11	2I2/45/6L	26	4000A50/6	112	582PM2505/3	129
2E2/30/6L	16	2I2/45/6LAN	26	4000A60/0	112	582PM2505/4	129
2E2/30/6LAN	16	2I2/45/6U	26	4000A60/6	112	582PM2525/3	128



**ÍNDICE POR REFERENCIA**

REF.	PÁG.	REF.	PÁG.	REF.	PÁG.	REF.	PÁG.
582PM2525/4	128	590PM3005/3	133	5968P3030/3	145	5982/4060/4	127
582PM2530/3	128	590PM3005/4	133	5968P3030/4	145	5982/4070/3	127
582PM2530/4	128	590PM3030/3	132	5968T25/3	145	5982/4070/4	127
582PM2535/3	128	590PM3030/4	132	5968T25/4	145	5982/4080/3	127
582PM2535/4	128	590PM3045/3	132	5968T30/3	145	5982/4080/4	127
582PM2540/3	128	590PM3045/4	132	5968T30/4	145	5982/4545/3	127
582PM2540/4	128	590PM30T30/3	133	5968T40/3	145	5982/4545/4	127
582PM2545/3	128	590PM30T30/4	133	5968T40/4	145	5982/4555/3	127
582PM2545/4	128	590PM30T45/3	133	5979/3030/3	146	5982/4555/4	127
582PM2550/3	128	590PM30T45/4	133	5979/3030/4	146	5982/5050/3	127
582PM2550/4	128	590PM3505/3	133	5979P3030/3	146	5982/5050/4	127
582PM2555/3	128	590PM3505/4	133	5979P3030/4	146	5982/5555/3	127
582PM2555/4	128	590PM3525/3	132	5982/2525/3	126	5982/5555/4	127
582PM2560/3	128	590PM3525/4	132	5982/2525/4	126	5982/6060/3	127
582PM2560/4	128	590PM3535/3	132	5982/2530/3	126	5982/6060/4	127
582PM2565/3	128	590PM3535/4	132	5982/2530/4	126	5982/6565/3	127
582PM2565/4	128	590PM3540/3	132	5982/2535/3	126	5982/6565/4	127
582PM25T25/3	129	590PM3540/4	132	5982/2535/4	126	5982/7070/3	127
582PM25T25/4	129	590PM3545/3	132	5982/2540/3	126	5982/7070/4	127
582PM3005/3	129	590PM3545/4	132	5982/2540/4	126	5982/7575/3	127
582PM3005/4	129	590PM35T25/3	133	5982/2545/3	126	5982/7575/4	127
582PM3030/3	128	590PM35T25/4	133	5982/2545/4	126	5982C16	53
582PM3030/4	128	590PM35T35/3	133	5982/2550/3	126	5982C16	124
582PM3045/3	128	590PM35T35/4	133	5982/2550/4	126	5982C20	124
582PM3045/4	128	590PM4005/3	133	5982/2555/3	126	5982PT2505/3	129
582PM30T30/3	129	590PM4005/4	133	5982/2555/4	126	5982PT2505/4	129
582PM30T30/4	129	590PM4505/3	133	5982/2560/3	126	5982PT2525/3	129
582PM30T45/3	129	590PM4505/4	133	5982/2560/4	126	5982PT2525/4	129
582PM30T45/4	129	590PM5005/3	133	5982/2565/3	126	5982PT2535/3	129
582PM3505/3	129	590PM5005/4	133	5982/2565/4	126	5982PT2535/4	129
582PM3505/4	129	590PM5505/3	133	5982/2575/3	127	5982PT2545/3	129
582PM3525/3	128	590PM5505/4	133	5982/2575/4	127	5982PT2545/4	129
582PM3525/4	128	5961/2525/3	142	5982/2585/3	127	5982T40/3	128
582PM3535/3	128	5961/2525/4	142	5982/2585/4	127	5982T40/4	128
582PM3535/4	128	5961/3030/3	142	5982/2595/3	127	5982T45/3	128
582PM3540/3	128	5961/3030/4	142	5982/2595/4	127	5982T45/4	128
582PM3540/4	128	5962/2525/3	143	5982/3030/3	126	5982T50/3	128
582PM3545/3	128	5962/3030/3	143	5982/3030/4	126	5982T50/4	128
582PM3545/4	128	5962/4040/3	143	5982/3035/3	126	5982T55/3	128
582PM35T25/3	129	5962T30/3	143	5982/3035/4	126	5982T55/4	128
582PM35T25/4	129	5962T40/3	143	5982/3040/3	126	5982T60/3	128
582PM35T35/3	129	5963/2222/3	140	5982/3040/4	126	5982T60/4	128
582PM35T35/4	129	5963/2222/4	140	5982/3045/3	126	5982T65/3	128
582PM4005/3	129	5963/2525/3	140	5982/3045/4	126	5982T65/4	128
582PM4005/4	129	5963/2525/4	140	5982/3050/3	126	5982T70/3	128
582PM4505/3	129	5963/3030/3	140	5982/3050/4	126	5982T70/4	128
582PM4505/4	129	5963/3030/4	140	5982/3055/3	126	5990/2525/3	130
582PM5005/3	129	5963/3535/3	140	5982/3055/4	126	5990/2525/4	130
582PM5005/4	129	5963/3535/4	140	5982/3060/3	126	5990/2530/3	130
582PM5505/3	129	5963/4040/3	140	5982/3060/4	126	5990/2530/4	130
582PM5505/4	129	5963/4040/4	140	5982/3080/3	127	5990/2535/3	130
590PM2505/3	133	5963T36/3	140	5982/3080/4	127	5990/2535/4	130
590PM2505/4	133	5963T36/4	140	5982/3535/3	126	5990/2540/3	130
590PM2525/3	132	5964/2525/3	144	5982/3535/4	126	5990/2540/4	130
590PM2525/4	132	5964/2525/4	144	5982/3540/3	126	5990/2545/3	130
590PM2530/3	132	5964/3030/3	144	5982/3540/4	126	5990/2545/4	130
590PM2530/4	132	5964/3030/4	144	5982/3545/3	126	5990/2550/3	130
590PM2535/3	132	5964/4040/3	144	5982/3545/4	126	5990/2550/4	130
590PM2535/4	132	5964/4040/4	144	5982/3555/3	126	5990/2555/3	130
590PM2540/3	132	5964P3030/3	144	5982/3555/4	126	5990/2555/4	130
590PM2540/4	132	5964P3030/4	144	5982/3565/3	127	5990/2560/3	130
590PM2545/3	132	5964T25/3	144	5982/3565/4	127	5990/2560/4	130
590PM2545/4	132	5964T25/4	144	5982/3575/3	127	5990/2565/3	130
590PM2550/3	132	5964T30/3	144	5982/3575/4	127	5990/2565/4	130
590PM2550/4	132	5964T30/4	144	5982/3595/3	127	5990/2575/3	131
590PM2555/3	132	5964T40/3	144	5982/3595/4	127	5990/2575/4	131
590PM2555/4	132	5964T40/4	144	5982/4040/3	126	5990/2585/3	131
590PM2560/3	132	5968/2525/3	145	5982/4040/4	126	5990/2585/4	131
590PM2560/4	132	5968/2525/4	145	5982/4050/3	127	5990/2595/3	131
590PM2565/3	132	5968/3030/3	145	5982/4050/4	127	5990/2595/4	131
590PM2565/4	132	5968/3030/4	145	5982/4055/3	127	5990/3030/3	130
590PM25T25/3	133	5968/4040/3	145	5982/4055/4	127	5990/3030/4	130
590PM25T25/4	133	5968/4040/4	145	5982/4060/3	127	5990/3035/3	130

## ÍNDICE POR REFERENCIA

REF.	PÁG.	REF.	PÁG.	REF.	PÁG.	REF.	PÁG.
5990/3035/4	130	5990T60/3	132	690PM3555/4	139	6982/5050/3	135
5990/3040/3	130	5990T60/4	132	690PM3565/3	139	6982/5050/4	135
5990/3040/4	130	5990T65/3	132	690PM3565/4	139	6982/5555/3	135
5990/3045/3	130	5990T65/4	132	6964/3030/3	144	6982/5555/4	135
5990/3045/4	130	5990T70/3	132	6964/3030/4	144	6982/6565/3	135
5990/3050/3	130	5990T70/4	132	6964T30/3	144	6982/6565/4	135
5990/3050/4	130	6000D/1N	151	6964T30/4	144	6982/7070/3	135
5990/3055/3	130	6000D/1NM	151	6968/3030/3	145	6982/7070/4	135
5990/3055/4	130	6000D/6	151	6968/3030/4	145	6982/7575/3	135
5990/3060/3	131	6000I/1N	151	6968T30/3	145	6982/7575/4	135
5990/3060/4	131	6000I/1NM	151	6968T30/4	145	6982T40/3	136
5990/3080/3	131	6000I/6	151	6982/2525/3	134	6982T40/4	136
5990/3080/4	131	612/25/6	28	6982/2525/4	134	6982T50/3	136
5990/3535/3	130	612/25/6	152	6982/2530/3	134	6982T50/4	136
5990/3535/4	130	612/30/6	28	6982/2530/4	134	6982T60/3	136
5990/3540/3	130	612/30/6	152	6982/2535/3	134	6982T60/4	136
5990/3540/4	130	612/35/6	28	6982/2535/4	134	6982T70/3	136
5990/3545/3	130	612/35/6	152	6982/2540/3	134	6982T70/4	136
5990/3545/4	130	612E/25/6	29	6982/2540/4	134	6990/2525/3	137
5990/3555/3	131	612E/25/6	153	6982/2545/3	134	6990/2525/4	137
5990/3555/4	131	612E/30/6	29	6982/2545/4	134	6990/2530/3	137
5990/3565/3	131	612E/30/6	153	6982/2550/3	134	6990/2530/4	137
5990/3565/4	131	612E/35/6	29	6982/2550/4	134	6990/2535/3	137
5990/3575/3	131	612E/35/6	153	6982/2555/3	134	6990/2535/4	137
5990/3575/4	131	615/25/6	28	6982/2555/4	134	6990/2540/3	137
5990/3595/3	131	615/25/6	152	6982/2560/3	134	6990/2540/4	137
5990/3595/4	131	615/30/6	28	6982/2560/4	134	6990/2545/3	137
5990/4040/3	130	615/30/6	152	6982/2565/3	135	6990/2545/4	137
5990/4040/4	130	615/35/6	28	6982/2565/4	135	6990/2550/3	137
5990/4050/3	131	615/35/6	152	6982/2575/3	135	6990/2550/4	137
5990/4050/4	131	615E/25/6	29	6982/2575/4	135	6990/2555/3	137
5990/4055/3	131	615E/25/6	153	6982/2585/3	135	6990/2555/4	137
5990/4055/4	131	615E/30/6	29	6982/2585/4	135	6990/2560/3	137
5990/4060/3	131	615E/30/6	153	6982/2595/3	135	6990/2560/4	137
5990/4060/4	131	615E/35/6	29	6982/2595/4	135	6990/2565/3	138
5990/4070/3	131	615E/35/6	153	6982/3030/3	134	6990/2565/4	138
5990/4070/4	131	682PM2525/3	136	6982/3030/4	134	6990/2575/3	138
5990/4080/3	131	682PM2525/4	136	6982/3035/3	134	6990/2575/4	138
5990/4080/4	131	682PM2535/3	136	6982/3035/4	134	6990/2585/3	138
5990/4545/3	131	682PM2535/4	136	6982/3040/3	134	6990/2585/4	138
5990/4545/4	131	682PM2545/3	136	6982/3040/4	134	6990/2595/3	138
5990/4555/3	131	682PM2545/4	136	6982/3045/3	134	6990/2595/4	138
5990/4555/4	131	682PM2555/3	136	6982/3045/4	134	6990/3030/3	137
5990/5050/3	131	682PM2555/4	136	6982/3050/3	134	6990/3030/4	137
5990/5050/4	131	682PM3030/3	136	6982/3050/4	134	6990/3035/3	137
5990/5555/3	131	682PM3030/4	136	6982/3055/3	134	6990/3035/4	137
5990/5555/4	131	682PM3525/3	136	6982/3055/4	134	6990/3040/3	137
5990/6060/3	131	682PM3525/4	136	6982/3060/3	135	6990/3040/4	137
5990/6060/4	131	682PM3535/3	136	6982/3060/4	135	6990/3045/3	137
5990/6565/3	131	682PM3535/4	136	6982/3535/3	134	6990/3045/4	137
5990/6565/4	131	682PM3545/3	136	6982/3535/4	134	6990/3050/3	137
5990/7070/3	131	682PM3545/4	136	6982/3540/3	134	6990/3050/4	137
5990/7070/4	131	682PM3555/3	136	6982/3540/4	134	6990/3055/3	137
5990/7575/3	131	682PM3555/4	136	6982/3545/3	134	6990/3055/4	137
5990/7575/4	131	682PM3565/3	136	6982/3545/4	134	6990/3060/3	138
5990C16	53	682PM3565/4	136	6982/3555/3	135	6990/3060/4	138
5990C20	94	690PM2525/3	139	6982/3555/4	135	6990/3535/3	137
5990PT2505/3	133	690PM2525/4	139	6982/3565/3	135	6990/3535/4	137
5990PT2505/4	133	690PM2535/3	139	6982/3565/4	135	6990/3540/3	137
5990PT2525/3	133	690PM2535/4	139	6982/4040/3	134	6990/3540/4	137
5990PT2525/4	133	690PM2545/3	139	6982/4040/4	134	6990/3545/3	137
5990PT2535/3	133	690PM2545/4	139	6982/4045/3	134	6990/3545/4	137
5990PT2535/4	133	690PM2555/3	139	6982/4045/4	134	6990/3555/3	138
5990PT2545/3	133	690PM2555/4	139	6982/4050/3	135	6990/3555/4	138
5990PT2545/4	133	690PM3030/3	139	6982/4050/4	135	6990/3565/3	138
5990T40/3	132	690PM3030/4	139	6982/4055/3	135	6990/3565/4	138
5990T40/4	132	690PM3525/3	139	6982/4055/4	135	6990/4040/3	137
5990T45/3	132	690PM3525/4	139	6982/4545/3	135	6990/4040/4	137
5990T45/4	132	690PM3535/3	139	6982/4545/4	135	6990/4045/3	137
5990T50/3	132	690PM3535/4	139	6982/4555/3	135	6990/4045/4	137
5990T50/4	132	690PM3545/3	139	6982/4555/4	135	6990/4050/3	138
5990T55/3	132	690PM3545/4	139	6982/4560/3	135	6990/4050/4	138
5990T55/4	132	690PM3555/3	139	6982/4560/4	135	6990/4055/3	138



**ÍNDICE POR REFERENCIA**

REF.	PÁG.	REF.	PÁG.	REF.	PÁG.	REF.	PÁG.
6990/4055/4	138	CE196/6LAN	43	CEB6000/1N	161	M5002/1N	160
6990/4545/3	138	CE196/6LR	43	CEC41/6AD	50	M5003/1N	160
6990/4545/4	138	CE196/6U	43	CEC41T/6AD	50	M5004/1N	160
6990/4555/3	138	CE1960/2	122	CELC45/6A	93	P192/25/6	37
6990/4555/4	138	CE1960/6	122	CELC45/6AD	93	P192/30/6	37
6990/4560/3	138	CE1960A/2	122	CELC45T/6A	93	P192/35/6	37
6990/4560/4	138	CE1960A/6	122	CELC45T/6AD	93	P192V25/6	37
6990/5050/3	138	CE196R/6L	45	CM5006D55/6R	159	P192V30/6	37
6990/5050/4	138	CE196R/6LAN	45	CM5006D72/6R	159	P192V35/6	37
6990/5555/3	138	CE196R/6LR	45	CM5006D85/6R	159	P198K25/6	61
6990/5555/4	138	CE1970A/2	122	CM5006I55/6R	159	P198K30/6	61
6990/6565/3	138	CE1970A/6	122	CM5006I72/6R	159	P198K35/6	61
6990/6565/4	138	CE1970R/2	122	CM5006I85/6R	159	P198KB25/6	61
6990/7070/3	138	CE1970R/6	122	CM5007D/6R	159	P198KB30/6	61
6990/7070/4	138	CE1975R/0	92	CM5007I/6R	159	P198KB35/6	61
6990/7575/3	138	CE1983/6	90	CONNECT01	55	P198KD20/6	61
6990/7575/4	138	CE1984/0	90	CVIE5	55	P1E2/30/6	18
6990T40/3	139	CE1984/6	90	EMB196	55	P1E2/35/6	18
6990T40/4	139	CE1985/2	121	ES184/1B	54	P1E2/40/6	18
6990T50/3	139	CE1985/6	121	ES184/1N	54	P1E2/45/6	18
6990T50/4	139	CE1990/0	91	ES1960	123	P1E2/50/6	18
6990T60/3	139	CE1991/0	91	ES1960/4	123	P2E2/30/6	16
6990T60/4	139	CE1994/6	91	ES1962	123	P2E2/35/6	16
6990T70/3	139	CE202GB/1NR	48	ES1962/4	123	P2E2/40/6	16
6990T70/4	139	CE202GB/1NRS	48	ES1963	94	P2E2/45/6	16
AE70/6L	10	CE202GB/6L	48	ES1964	94	P2E2/50/6	16
AI70/6L	10	CE202GB/6LAN	49	ES1964	123	P2E2GB30/6	15
AIK70/6L	10	CE202GB6LR18	49	ES1984	54	P2E2GB35/6	15
B5000	161	CE202GB6LR20	49	ES1984	94	P2E2GB40/6	15
B5000/4	161	CE202S/1NR	48	ES1985/0	123	P2E2GB45/6	15
BAR5000/1R	161	CE202S/1NRS	48	ES1985/7	123	P2E2GB50/6	15
BAR5000/1RE	161	CE202S/6L	48	FA12VDC3A1	164	P2I2/30/6	26
BAR5000/1RE2	161	CE202S/6LAN	48	JES6000/6R	52	P2I2/33/6	26
BAR5000/6	161	CE202S/6LR18	49	JM6006/85/1B	51	P2I2/35/6	26
BAR5000/6E	161	CE202S/6LR20	49	JM6006/85/1N	51	P2I2/38/6	26
BTI296/1N	54	CE202S/6U	49	JM6006/85/6R	51	P2I2/45/6	26
BTI94/1N	54	CE249R/2	122	JM6006P/85/1B	51	P2I2/55/6	26
BTI94/1N	94	CE249R/6	122	JM6006P/85/1N	51	P2I2GB30/6	25
CACE/AB/E	55	CE296S/1NR	45	JMB6000/6R	51	P2I2GB33/6	25
CACE/PA/E	55	CE296S/1NRS	45	JT6006/85/6R	52	P2I2GB35/6	25
CACE/RES/ES	55	CE296S/6L	44	KCE1K5/1NR	47	P2I2GB38/6	25
CE184/0L	42	CE296S/6LAN	44	KCE1K5/1NRS	47	P2I2GB45/6	25
CE184/0LAN	42	CE296S/6LR	44	KCE1K5/6L	47	P2I2GB55/6	25
CE184/1N	42	CE296S/6U	44	KCE1K5/6LR	47	PASCABO1	164
CE184/1NR	42	CE2994S/6	92	KES4000	123	PASCABS1	164
CE184/1NRS	42	CE2A2S/1N22	46	KES4100	123	RECARGO	
CE184/6L	42	CE2A2S/1NR	46	KLECH1/6	164	CONFIGURACIÓN	
CE184/6LAN	42	CE2A2S/1NRS	46	KLECP1	164	TARJETA MIFARE	164
CE184/6LR	42	CE2A2S/6L	46	KLECT1/N	164	TAG1	164
CE184/6U	42	CE2A2S/6LR	46	KSM2A2	13	TAPIE5	55
CE184A/6L	43	CE4000/2	121	KTVCE13	55	TARJ1	164
CE190/0	90	CE4000/6	121	KTVCE15	55	TUF6000/1N	161
CE190/6	90	CE4001/2	121	LLAVERO1	164	TUF6000/1NE	161
CE196/1N	43	CE4001/6	121	M50001D/1N	160	TUF6000/1NE2	161
CE196/1NR	44	CE5000/1N	161	M5000D/1N	160	TUF6000/6	161
CE196/1NRS	44	CE5000/6	161	M5000I/1N	160	TUF6000/6E	161
CE196/6L	43	CEB6000	161	M5001I/1N	160		

## CONDICIONES DE VENTA

- Los precios de esta tarifa están sujetos al impuesto IVA.
- Los portes serán a cargo del cliente si la agencia de transporte indicada por éste no es una de las seleccionadas por CVL
- Todo pedido implica la aceptación, sin reservas, de todas las condiciones de venta.
- Los códigos EAN corresponden siempre a la cerradura estándar completa.
- La empresa se reserva el derecho a modificar sin previo aviso sus modelos, características y especificaciones.

### PORTES PENÍNSULA Y BALEARES

- Los pedidos superiores a 500 € se pondrán en destino a portes pagados cuando la entrega se realice por las agencias de transporte seleccionadas por CVL.
- Si el pedido es inferior a 100 €, los portes serán 10 €.
- Si el pedido es entre 101 € y 499 € se cargarán 6,01 € + 3% de portes.

### PORTES CANARIAS

- Los pedidos superiores a 1.000 € se pondrán en destino a portes pagados, cuando la entrega se haga por las agencias de transportes seleccionadas por CVL.
- Si el pedido es inferior consultar porte.

### ABREVIATURAS DE ACABADOS CERRADURAS Y CILINDROS

COD.	FRENTE	CILINDRO
/0	Hierro Niquelado <b>(HN)</b>	Latón Niquelado <b>(CN)</b>
/1	Hierro Esmaltado <b>(HE)</b>	Latón Pulido <b>(LP)</b>
/2	Hierro Latonado <b>(HL)</b>	Latón Pulido <b>(LP)</b>
/3		Latón Pulido <b>(LP)</b>
/4		Latón Niquelado <b>(CN)</b>
/5	Hierro Niquelado <b>(HN)</b>	Latón Pulido <b>(LP)</b>
/6	Acero Inoxidable <b>(AI)</b>	Latón Niquelado <b>(CN)</b>
/7	Níquel Satinado <b>(NS)</b>	Latón Niquelado <b>(CN)</b>

### ABREVIATURAS DE ACABADOS DE ANTIPÁNICOS Y ESCUDOS

COD.	ACABADO
/0	Niquelado
/1N	Pintado negro
/1NM	Pintado níquel mate
/2	Latonado
/6	Acero inoxidable
/7	Níquel mate

**PUERTAS BATIENTES**

**PUERTAS CORREDERAS**

SOLUCIÓN PARA PUERTAS ALTAS BATIENTES Y CORREDERA .....	10
<b>SOLUCIÓN PORTAL.....</b>	<b>11</b>
<b>SOLUCIONES DE APERTURA .....</b>	<b>12</b>
<b>Multipunto automática entre ejes 92 mm .....</b>	<b>13</b>
• Serie 2A2N <i>iself</i> .....	13
<b>Multipunto palanca deslizante entre ejes 92 mm .....</b>	<b>14</b>
• Serie 4E25 <i>soft</i> .....	14
• Serie 2E2GB <i>soft</i> .....	15
• Serie 2E2 <i>soft</i> .....	16
<b>Palanca deslizante entre ejes 92 mm.....</b>	<b>18</b>
• Serie 1E2 <i>soft</i> .....	18
<b>Multipunto palanca deslizante entre ejes 85 mm .....</b>	<b>20</b>
• Serie 2E5 <i>soft</i> .....	20
<b>Palanca deslizante entre ejes 85 mm.....</b>	<b>21</b>
• Serie 1E5 <i>soft</i> .....	21
<b>Multipunto palanca basculante entre ejes 85 mm .....</b>	<b>22</b>
• Serie 2K5 <i>DUE</i> .....	22
<b>Palanca basculante entre ejes 85 mm.....</b>	<b>23</b>
• Serie 1K5 <i>DUE</i> .....	23
<b>Multipunto palanca deslizante entre ejes 92 mm .....</b>	<b>24</b>
• Serie 4I25 <i>inverse</i> .....	24
• Serie 2I2GB <i>inverse</i> .....	25
• Serie 2I2 <i>inverse</i> .....	26
<b>Multipunto palanca deslizante .....</b>	<b>27</b>
• Serie 3I2, 3I5 <i>inverse</i> .....	27
<b>Cerradura antipánico palanca deslizante.....</b>	<b>28</b>
• Series 615, 612 <i>alupanic</i> .....	28
• Series 615E, 612E <i>alupanic</i> .....	29
<b>Palanca deslizante entre ejes 85 mm.....</b>	<b>30</b>
• Serie 184 .....	30
<b>Multipunto palanca basculante entre ejes 85 mm .....</b>	<b>32</b>
• Serie 296 .....	32
<b>Palanca basculante entre ejes 85 mm.....</b>	<b>34</b>
• Serie 196 .....	34
<b>Palanca gancho entre ejes 85 mm .....</b>	<b>36</b>
• Serie 197 .....	36
<b>Palanca deslizante entre ejes 92 mm.....</b>	<b>37</b>
• Serie 192 .....	37
<b>Multipunto palanca basculante entre ejes 92 mm .....</b>	<b>38</b>
• Serie 294N.....	38
<b>Palanca basculante entre ejes 92 mm.....</b>	<b>40</b>
• Serie 194 .....	40
• Serie 194F.....	41
<b>Accesorios.....</b>	<b>42</b>
• Cerraderos.....	42
• Cerraderos eléctricos.....	50
• Escudos y manillas de acero inoxidable.....	51
• Kit condena .....	53
• Escudos .....	54
• Otros .....	55
<b>Multipunto palanca gancho entre ejes 85 mm .....</b>	<b>56</b>
• Serie 4I54K <i>slide &amp; lock</i> .....	56
• Serie 2I5K <i>slide &amp; lock</i> .....	57
<b>Palanca gancho entre ejes 85 mm .....</b>	<b>58</b>
• Serie 1I5K <i>slide &amp; lock</i> .....	58
<b>Multipunto palanca gancho .....</b>	<b>59</b>
• Serie 297K <i>slide &amp; lock</i> .....	59
<b>Palanca gancho y antifalsa maniobra.....</b>	<b>60</b>
• Serie 197KBN <i>slide &amp; lock</i> .....	60
<b>Palanca gancho con cilindro Europerfil .....</b>	<b>61</b>
• Serie 198K <i>slide &amp; lock</i> .....	61
<b>Palanca gancho con cilindro tetra.....</b>	<b>62</b>
• Serie 1T8 <i>slide &amp; lock</i> .....	62



## SOLUCIÓN PARA PUERTAS ALTAS BATIENTES Y CORREDERA

## BATIENTES

## CORREDERA

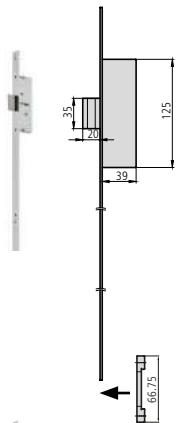

**AE70**  
(ver abajo)

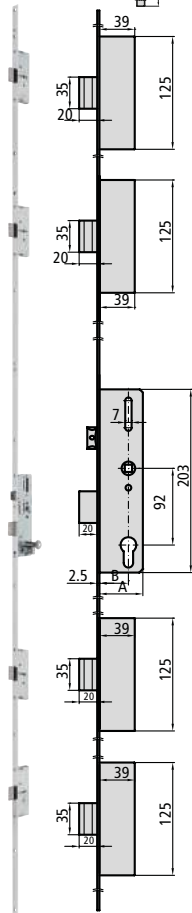

**AE25**  
(ver pág. 14)

**soft**

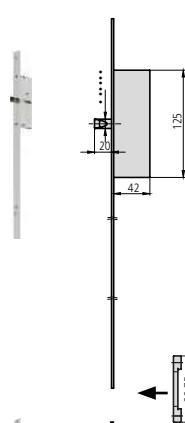

**AI70**  
(ver abajo)

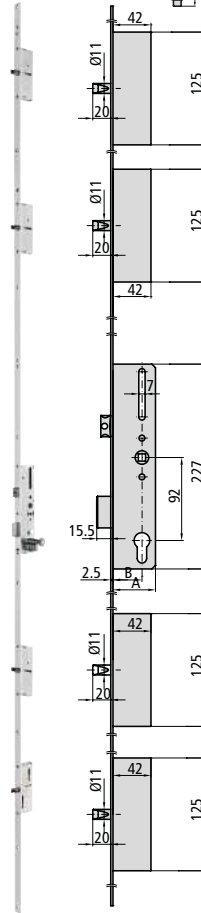

**AI25**  
(ver pág. 26)

**inverse**

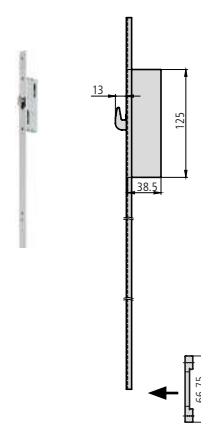

**AIK70**  
(ver abajo)

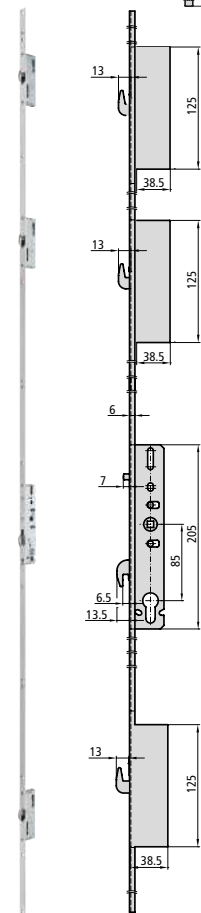

**AI54K**  
(ver pág. 57)

**slide & lock**

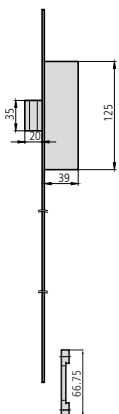

**AE70**

- Kit acople y punto de cierre adicional para cerradura de 2300 mm.
- Palanca deslizante.
- Frente inox.
- Frente de 700 mm de largo.

AE70/6L

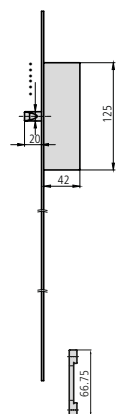

**AI70**

- Kit acople y punto de cierre adicional para cerradura de 2300 mm.
- Con bulón.
- Frente inox.
- Frente de 700 mm de largo.

AI70/6L

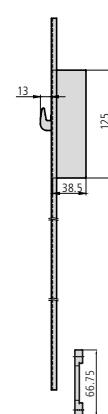

**AIK70**

- Kit acople y punto de cierre adicional para cerradura de 2300 mm.
- Palanca de gancho.
- Frente inox.
- Frente de 700 mm de largo.

AIK70/6L

## PUERTAS BATIENTES

MULTIPUNTO AUTOMÁTICA ENTRE EJES 92 mm

SERIE 2A2N **iself**

ALUMINIO

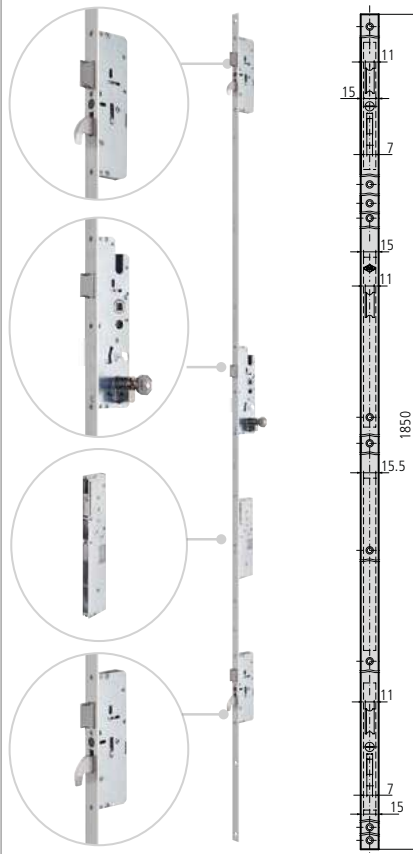

### CARACTERÍSTICAS

- Sistema de cierre autónomo mediante 3 resbalones y 2 ganchos alto/bajo
- Disparo automático de los ganchos alto/bajo (independientes) mediante tecnología magnética
- Fondo de caja 15 mm: evita el mecanizado del perfil en la parte trasera
- Atado de manilla pasante a 21,5 mm  
↓ y a partir de 45 mm ↑ .
- Frente liso inox de 16 mm, 22 mm, 24 mm y U 24,5\*6
- Resbalones reversibles mediante sistema semiautomático
- Caja cerrada de 15 mm
- Cuadradillo de 8 mm
- Cerraderos de serie
- Tornillo de fijación de cilindro

### ACCESORIOS OPCIONALES

- Gama completa de cerraderos (ver páginas 44 - 51)
- Gama completa de cilindros (ver página 128 - 148)

### OTRAS OPCIONES

- Posibilidad de distintas alturas de frente.

### DESCRIPCIÓN

REF.

MEDIDAS  
B A

LEVA

ACABADOS  
FRENTE CILINDRO

UDS

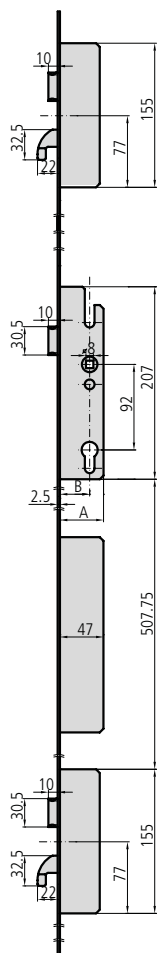
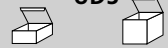

- Cilindro no incluido
- Motor incluido

**Opciones de cerradero**  
(ver páginas 44 - 51)

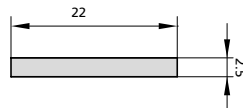

2A2NM30/6L	27	42	15	Al	1
2A2NM35/6L	32	47	15	Al	1
2A2NM45/6L	42	57	15	Al	1

### IMPORTANTE:

El motor KSM2A2 funciona con corriente continua DC.  
Incluye cable de 3 hilos y 6 m de largo.

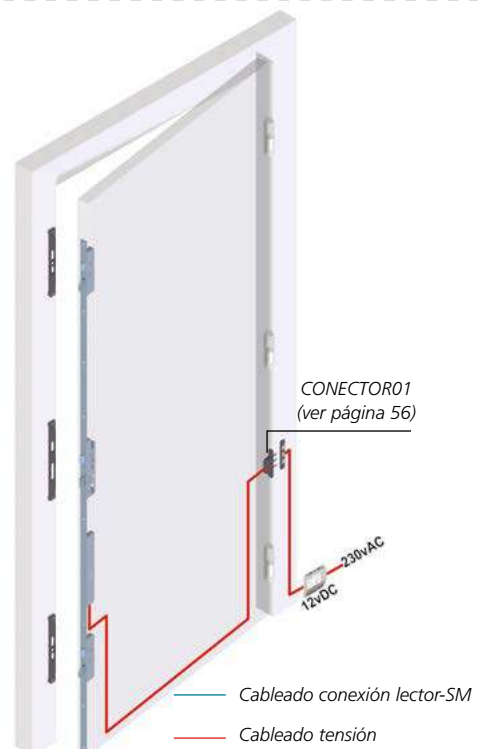

# ISELF MOTORIZADA

ALUMINIO

## PUERTAS BATIENTES

### Soluciones de apertura





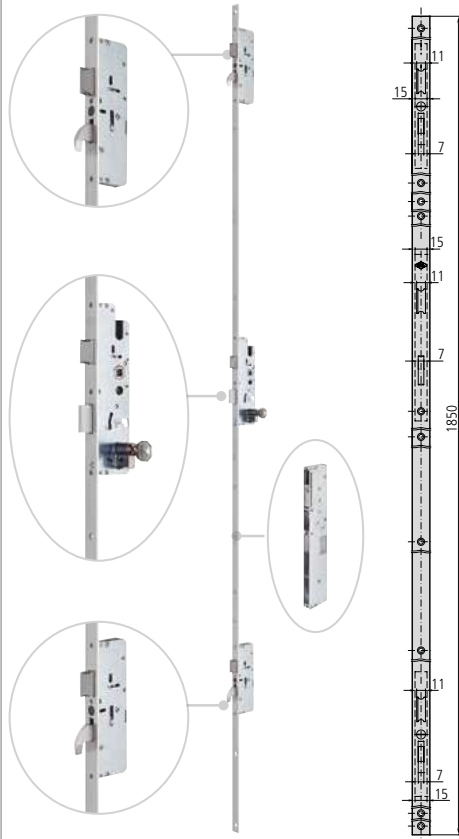

**CARACTERÍSTICAS**

- Sistema de cierre autónomo mediante 3 resbalones y 2 ganchos alto/bajo
- Disparo automático de los ganchos alto/bajo (independientes) mediante tecnología magnética
- Bloqueo total del sistema mediante palanca deslizante central accionada con llave
- Fondo de caja 15 mm: evita el mecanizado del perfil en la parte trasera
- Atado de manilla pasante a 21,5 mm ↓ y a partir de 45 mm ↑ .
- Frente de 1850 mm de largo
- Frente liso inox de 16 mm, 22 mm, 24 mm y U 24,5\*6
- Resbalones reversibles mediante sistema semiautomático
- Caja cerrada de 15 mm
- Cuadradillo de 8 mm
- Cerraderos de serie
- Tornillo de fijación de cilindro

**ACCESORIOS OPCIONALES**

- Gama completa de cerraderos (ver páginas 44 - 51)
- Gama completa de cilindros (ver página 128 - 148)

**OTRAS OPCIONES**

- Posibilidad de distintas alturas de frente.

DESCRIPCIÓN	REF.	MEDIDAS		LEVA	ACABADOS		UDS
		B	A		FRENTE	CILINDRO	

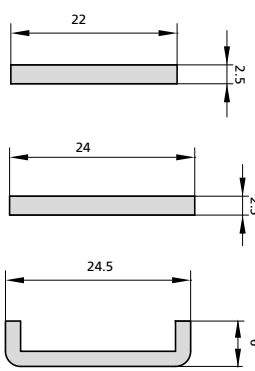
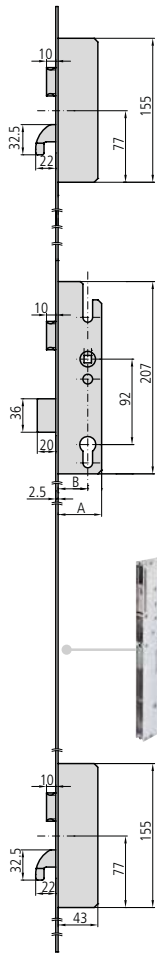

2A2N/30/6L	27	42	15	Al	1
2A2N/35/6L	32	47	15	Al	1
2A2N/45/6L	42	57	15	Al	1
2A2N/30/6LAN	27	42	15	Al	1
2A2N/35/6LAN	30	45	15	Al	1
2A2N/45/6LAN	32	47	15	Al	1
2A2N/30/6U	23	38	15	Al	1
2A2N/35/6U	28	43	15	Al	1
2A2N/45/6U	38	53	15	Al	1

- Cilindro no incluido
- Motor no incluido

**Opciones de cerradero**  
(ver páginas 44 - 51)

DESCRIPCIÓN	REF.
• Suplemento electro-mecánico inteligente para motorización de la cerradura	KSM2A2

**IMPORTANTE:**

El motor KSM2A2 funciona con corriente continua DC. Incluye cable de 3 hilos y 6 m de largo.

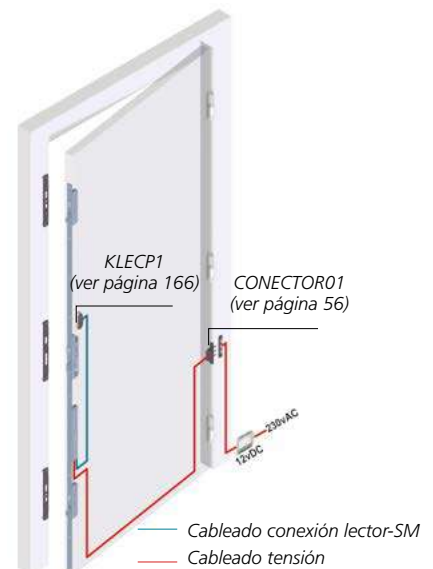

## PUERTAS BATIENTES

## MULTIPUNTO PALANCA DESLIZANTE ENTRE EJES 92 mm

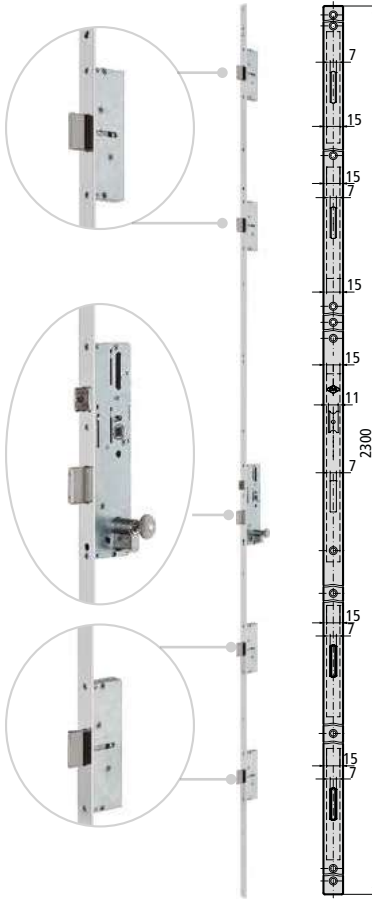
SERIE 4E25 **Soft**

## CARACTERÍSTICAS

- Máxima suavidad entre engranajes
- Cerradura de 5 puntos con frente liso inox de 22 mm
- Frente de 2300 mm de largo
- Picaporte reversible y regulable de 11 mm
- Punto alto y bajo con palanca deslizante
- Mínimo stock: 3 versiones en 1 cerradura (picaporte/rodillo/sólo palanca)
- Palanca deslizante
- Diseño según norma EN12209 y pr. EN 15685
- Compatible con cilindros de leva corta y leva larga/ DIN
- Caja cerrada de 15 mm
- Cuadradillo de 8 mm
- Tornillo de fijación de cilindro

## ACCESORIOS OPCIONALES

- Gama completa de cerraderos (ver páginas 44 - 51)
- Gama completa de cilindros (ver página 128 - 148)
- Kit acople y punto de cierre adicional (ver página 10)
- Kit vaivén para sustituir picaporte (ref. CV1E5) (ver página 56)

## DESCRIPCIÓN

## REF.

MEDIDAS  
B A

## LEVA

ACABADOS  
FRENTE CILINDRO

## UDS

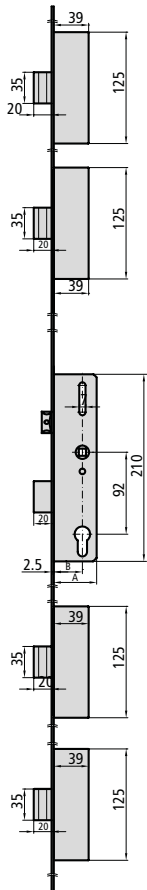
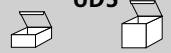

- Picaporte y palanca
- Cilindro no incluido

Opciones de cerradero  
(ver páginas 44 - 51)

4E25/30/6L	27	43	15/13,25	Al	1
4E25/35/6L	32	48	15/13,25	Al	1
4E25/40/6L	37	53	15/13,25	Al	1
4E25/45/6L	42	58	15/13,25	Al	1
4E25/50/6L	47	63	15/13,25	Al	1

MULTIPUNTO PALANCA DESLIZANTE ENTRE EJES 92 mm

SERIE 2E2GB **Soft**



CARACTERÍSTICAS

- Máxima suavidad entre engranajes
- Cerradura multipunto con frente liso inox de 16 mm, 22 mm, 24 mm y U 24,5\*6
- Frente de 1850 mm de largo
- Picaporte reversible y regulable de 11 mm
- Punto alto y bajo con gancho y bullón
- Mínimo stock: 3 versiones en 1 cerradura (picaporte/rodillo/sólo palanca)
- Palanca deslizante
- Diseño según norma EN12209 y pr. EN 15685
- Compatible con cilindros de leva corta y leva larga/ DIN
- Caja cerrada de 15 mm
- Cuadradillo de 8 mm
- Tornillo de fijación de cilindro

ACCESORIOS OPCIONALES

- Gama completa de cerraderos (ver páginas 44 - 51)
- Gama completa de cilindros (ver página 128 - 148)
- Frente de 2300 mm de largo opcional (serie 4E2GB)
- Frente de 1500 mm de largo opcional (serie 5E2GB)
- Kit vaivén para sustituir picaporte (ref. CV1E5) (ver página 56)

DESCRIPCIÓN	REF.	MEDIDAS		LEVA	ACABADOS		UDS	
		B	A		FRENTE	CILINDRO		

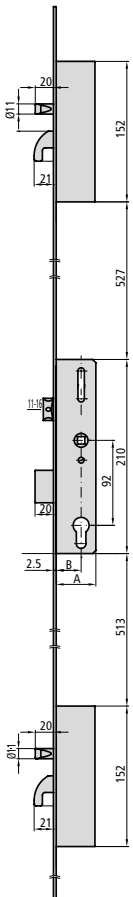

- Picaporte y palanca
- Cilindro no incluido

Opciones de cerradero (ver páginas 44 - 51)

	P2E2GB30/6	27	43	15/13,25	Al	1	
	P2E2GB35/6	32	48	15/13,25	Al	1	
	P2E2GB40/6	37	53	15/13,25	Al	1	
	P2E2GB45/6	42	58	15/13,25	Al	1	
	P2E2GB50/6	47	63	15/13,25	Al	1	
	2E2GB30/6L	27	43	15/13,25	Al	1	
	2E2GB35/6L	32	48	15/13,25	Al	1	
	2E2GB40/6L	37	53	15/13,25	Al	1	
	2E2GB45/6L	42	58	15/13,25	Al	1	
	2E2GB50/6L	47	63	15/13,25	Al	1	
	2E2GB30/6LAN	27	43	15/13,25	Al	1	
	2E2GB35/6LAN	32	48	15/13,25	Al	1	
	2E2GB40/6LAN	37	53	15/13,25	Al	1	
	2E2GB45/6LAN	42	58	15/13,25	Al	1	
	2E2GB50/6LAN	47	63	15/13,25	Al	1	
	2E2GB30/6U	23	39	15/13,25	Al	1	
	2E2GB35/6U	28	44	15/13,25	Al	1	
	2E2GB40/6U	33	49	15/13,25	Al	1	
	2E2GB45/6U	38	54	15/13,25	Al	1	
	2E2GB50/6U	43	59	15/13,25	Al	1	



## PUERTAS BATIENTES

## MULTIPUNTO PALANCA DESLIZANTE ENTRE EJES 92 mm

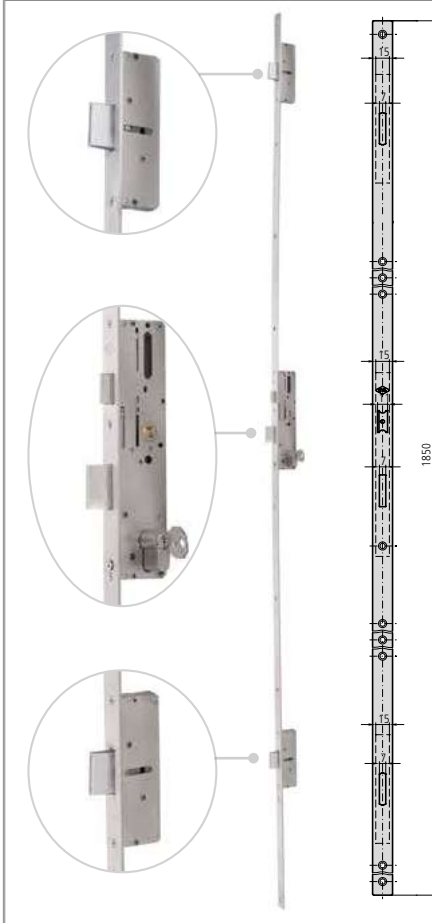
SERIE 2E2 **Soft**

## CARACTERÍSTICAS

- Máxima suavidad entre engranajes
- Cerradura de 3 puntos con frente liso inox de 16 mm, 22 mm, 24 mm y U 24,5\*6
- Frente de 1850 mm de largo
- Picaporte reversible y regulable de 11 mm
- Mínimo stock: 3 versiones en 1 cerradura (picaporte/rodillo/sólo palanca)
- Palanca deslizante
- Diseño según norma EN12209 y pr. EN 15685
- Compatible con cilindros de leva corta y leva larga/ DIN
- Caja cerrada de 15 mm
- Cuadradillo de 8 mm
- Tornillo de fijación de cilindro

## ACCESORIOS OPCIONALES

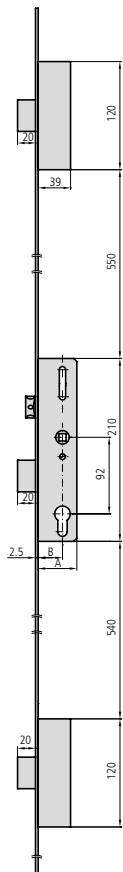

- Gama completa de cerraderos (ver páginas 44 - 51)
- Gama completa de cilindros (ver página 128 - 148)
- Frente de 2300 mm de largo opcional (serie 4E2)
- Frente de 1500 mm de largo opcional (serie 5E2)
- Kit vaivén para sustituir picaporte (ref. CV1E5) (ver página 56)

DESCRIPCIÓN	REF.	MEDIDAS		LEVA	ACABADOS		UDS
		B	A		FRENTE	CILINDRO	

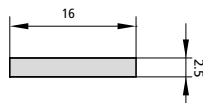

- Picaporte y palanca
- Cilindro no incluido

Opciones de cerradero  
(ver páginas 44 - 51)

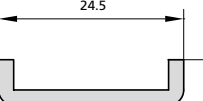
	P2E2/30/6	27	43	15/13,25	Al	1
	P2E2/35/6	32	48	15/13,25	Al	1
	P2E2/40/6	37	53	15/13,25	Al	1
	P2E2/45/6	42	58	15/13,25	Al	1
	P2E2/50/6	47	63	15/13,25	Al	1
	2E2/30/6L	27	43	15/13,25	Al	1
	2E2/35/6L	32	48	15/13,25	Al	1
	2E2/40/6L	37	53	15/13,25	Al	1
	2E2/45/6L	42	58	15/13,25	Al	1
	2E2/50/6L	47	63	15/13,25	Al	1
	2E2/30/6LAN	27	43	15/13,25	Al	1
	2E2/35/6LAN	32	48	15/13,25	Al	1
	2E2/40/6LAN	37	53	15/13,25	Al	1
	2E2/45/6LAN	42	58	15/13,25	Al	1
	2E2/50/6LAN	47	63	15/13,25	Al	1
	2E2/30/6U	23	39	15/13,25	Al	1
	2E2/35/6U	28	44	15/13,25	Al	1
	2E2/40/6U	33	49	15/13,25	Al	1
	2E2/45/6U	38	54	15/13,25	Al	1
	2E2/50/6U	43	59	15/13,25	Al	1



## PUERTAS BATIENTES

## PALANCA DESLIZANTE ENTRE EJES 92 mm

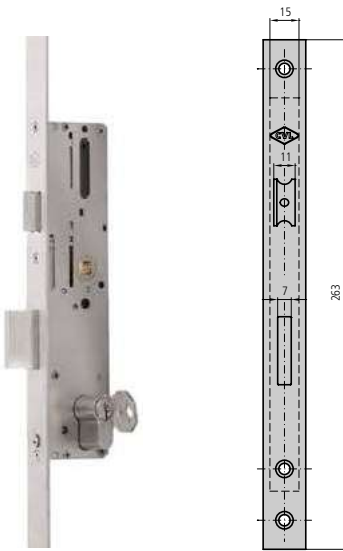
SERIE 1E2 **Soft**

## CARACTERÍSTICAS

- Máxima suavidad entre engranajes
- Frente liso inox de 16 mm, 22 mm, 24 mm y U 24,5\*6
- Picaporte reversible y regulable de 11 mm
- Mínimo stock: 3 versiones en 1 cerradura (picaporte/rodillo/sólo palanca)
- Palanca deslizante
- Diseño según norma EN12209 y pr. EN 15685
- Compatible con cilindros de leva corta y leva larga/ DIN
- Caja cerrada de 15 mm
- Cuadradillo de 8 mm
- Tornillo de fijación de cilindro

## ACCESORIOS OPCIONALES

- Gama completa de cerraderos (ver páginas 44 - 51)
- Gama completa de cilindros (ver página 128 - 148)
- Kit vaivén para sustituir picaporte (ref. CV1E5) (ver página 56)

## DESCRIPCIÓN

## REF.

## MEDIDAS

## LEVA

## ACABADOS

## UDS

B A

FRENTE CILINDRO

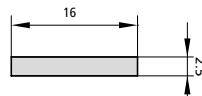

P1E2/30/6	27	43	15/13,25	Al	1
P1E2/35/6	32	48	15/13,25	Al	1
P1E2/40/6	37	53	15/13,25	Al	1
P1E2/45/6	42	58	15/13,25	Al	1
P1E2/50/6	47	63	15/13,25	Al	1

- Picaporte y palanca
- Cilindro no incluido

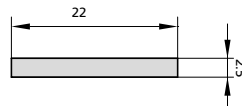
Opciones de cerradero  
(ver páginas 44 - 51)

1E2/30/6	27	43	15/13,25	Al	1
1E2/35/6	32	48	15/13,25	Al	1
1E2/40/6	37	53	15/13,25	Al	1
1E2/45/6	42	58	15/13,25	Al	1
1E2/50/6	47	63	15/13,25	Al	1

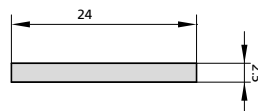

1E2/30/6AN	27	43	15/13,25	Al	1
1E2/35/6AN	32	48	15/13,25	Al	1
1E2/40/6AN	37	53	15/13,25	Al	1
1E2/45/6AN	42	58	15/13,25	Al	1
1E2/50/6AN	47	63	15/13,25	Al	1

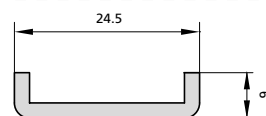

1E2/30/6U	23	39	15/13,25	Al	1
1E2/35/6U	28	44	15/13,25	Al	1
1E2/40/6U	33	49	15/13,25	Al	1
1E2/45/6U	38	54	15/13,25	Al	1
1E2/50/6U	43	59	15/13,25	Al	1

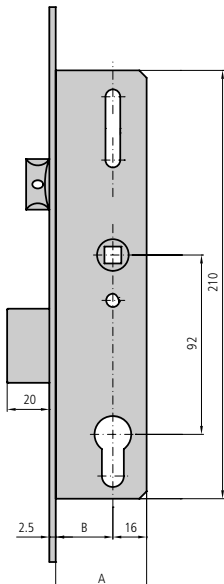

DESCRIPCIÓN	REF.	MEDIDAS		LEVA	ACABADOS		UDS
		B	A		FRENTE	CILINDRO	

- Rodillo vaivén regulable de nylon y palanca
- Cilindro no incluido

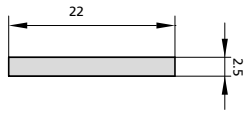
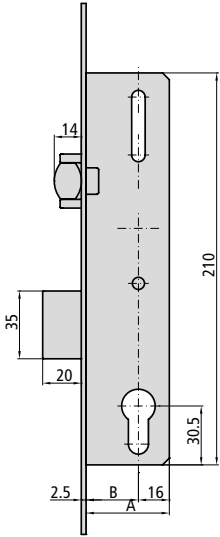
**Opciones de cerradero**  
 (ver páginas 44 - 51)

1E2NV/30/6	27	43	15/13,25	Al	1
1E2NV/35/6	32	48	15/13,25	Al	1
1E2NV/40/6	37	53	15/13,25	Al	1
1E2NV/45/6	42	58	15/13,25	Al	1
1E2NV/50/6	47	63	15/13,25	Al	1

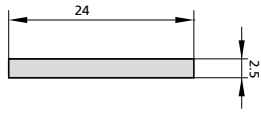

1E2NV/30/6AN	27	43	15/13,25	Al	1
1E2NV/35/6AN	32	48	15/13,25	Al	1
1E2NV/40/6AN	37	53	15/13,25	Al	1
1E2NV/45/6AN	42	58	15/13,25	Al	1
1E2NV/50/6AN	47	63	15/13,25	Al	1

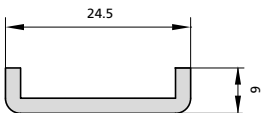

1E2NV/30/6U	23	39	15/13,25	Al	1
1E2NV/35/6U	28	44	15/13,25	Al	1
1E2NV/40/6U	33	49	15/13,25	Al	1
1E2NV/45/6U	38	54	15/13,25	Al	1
1E2NV/50/6U	43	59	15/13,25	Al	1

## PUERTAS BATIENTES

## MULTIPUNTO PALANCA DESLIZANTE ENTRE EJES 85 mm.

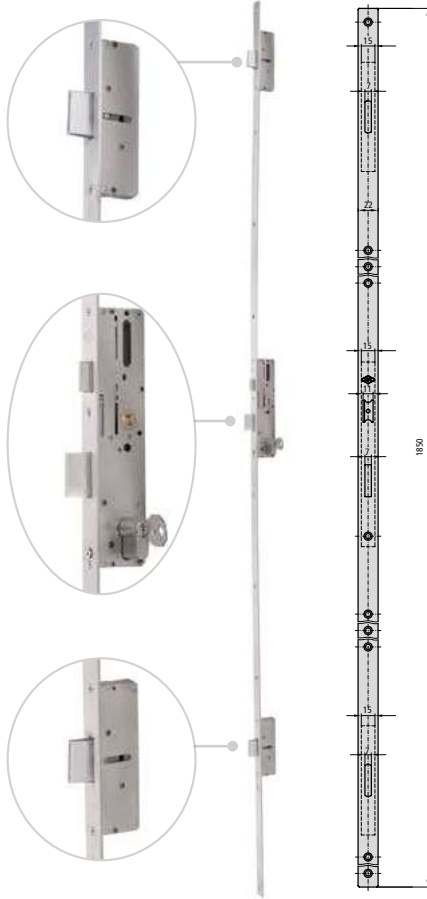
SERIE 2E5 **Soft**

## CARACTERÍSTICAS

- Máxima suavidad mediante engranajes
- Cerradura de 3 puntos con frente liso inox de 22 mm, 24 mm y U 24,5\*6
- Frente de 1850 mm de largo
- Picaporte reversible y regulable de 11 mm
- Mínimo stock: 3 versiones en 1 cerradura (picaporte/rodillo/sólo palanca)
- Palanca deslizante
- Diseño según norma EN12209 y pr. EN 15685
- Compatible con cilindros de leva corta y leva larga/ DIN
- Caja cerrada de 15 mm
- Cuadradillo de 8 mm
- Tornillo de fijación de cilindro

## ACCESORIOS OPCIONALES

- Gama completa de cerraderos (ver páginas 44 - 51)
- Gama completa de cilindros (ver página 128 - 148)
- Frente de 2300 mm de largo opcional (serie 4E5)
- Frente de 1500 mm de largo opcional (serie 5E5)
- Kit vaivén para sustituir picaporte (ref. CV1E5) (ver página 56)

## DESCRIPCIÓN

## REF.

MEDIDAS  
B A

## LEVA

ACABADOS  
FRENTE CILINDRO

## UDS

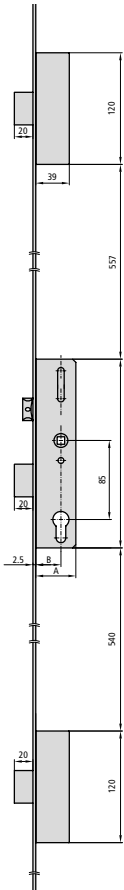
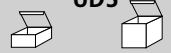

- Picaporte y palanca
- Cilindro no incluido

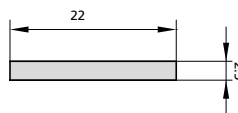
Opciones de cerradero  
(ver páginas 44 - 51)

2E5/30/6L	27	43	15/13,25	Al	1
2E5/35/6L	32	48	15/13,25	Al	1
2E5/40/6L	37	53	15/13,25	Al	1
2E5/45/6L	42	58	15/13,25	Al	1
2E5/50/6L	47	63	15/13,25	Al	1

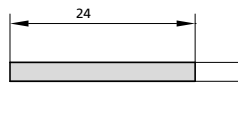

2E5/30/6LAN	27	43	15/13,25	Al	1
2E5/35/6LAN	32	48	15/13,25	Al	1
2E5/40/6LAN	37	53	15/13,25	Al	1
2E5/45/6LAN	42	58	15/13,25	Al	1
2E5/50/6LAN	47	63	15/13,25	Al	1

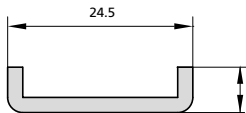

2E5/30/6U	23	39	15/13,25	Al	1
2E5/35/6U	28	44	15/13,25	Al	1
2E5/40/6U	33	49	15/13,25	Al	1
2E5/45/6U	38	54	15/13,25	Al	1
2E5/50/6U	43	59	15/13,25	Al	1

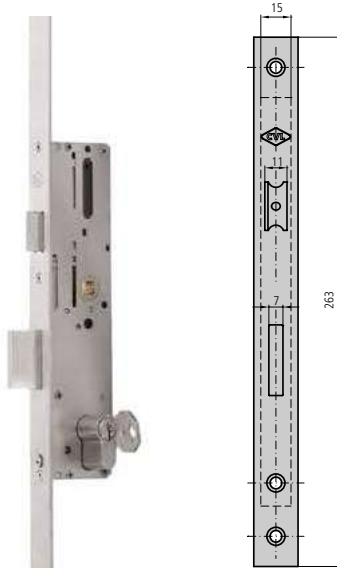

**PUERTAS BATIENTES**
**PALANCA DESLIZANTE ENTRE EJES 85 mm.**
**SERIE 1E5 *Soft***

**CARACTERÍSTICAS**

- Máxima suavidad mediante engranajes
- Cerradura de 1 punto con frente liso inox de 22 mm, 24 mm y U 24,5\*6
- Picaporte reversible y regulable de 11 mm
- Mínimo stock: 3 versiones en 1 cerradura (picaporte/rodillo/sólo palanca)
- Palanca deslizante
- Diseño según norma EN12209 y pr. EN 15685
- Compatible con cilindros de leva larga y leva corta/DIN
- Caja cerrada de 15 mm
- Cuadradillo de 8 mm
- Tornillo de fijación de cilindro

**ACCESORIOS OPCIONALES**

- Gama completa de cerraderos (ver páginas 44 - 51)
- Gama completa de cilindros (ver página 128 - 148)
- Kit vaivén para sustituir picaporte (ref. CV1E5) (ver página 56)

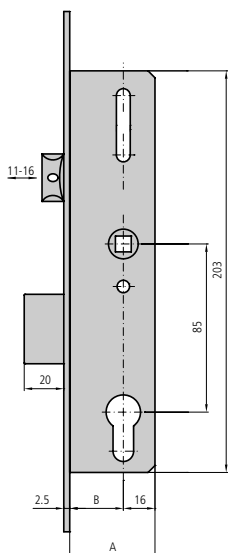
DESCRIPCIÓN	REF.	MEDIDAS		LEVA	ACABADOS		UDS	
		B	A		FRENTE	CILINDRO		



- Picaporte y palanca
- No incluye cilindro

**Opciones de cerradero**  
(ver páginas 44 - 51)

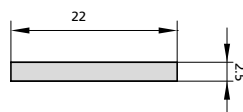

1E5/30/6	27	43	15/13,25	Al	1
1E5/35/6	32	48	15/13,25	Al	1
1E5/40/6	37	53	15/13,25	Al	1
1E5/45/6	42	58	15/13,25	Al	1
1E5/50/6	47	63	15/13,25	Al	1

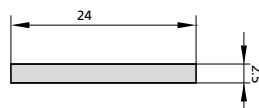

1E5/30/6AN	27	43	15/13,25	Al	1
1E5/35/6AN	32	48	15/13,25	Al	1
1E5/40/6AN	37	53	15/13,25	Al	1
1E5/45/6AN	42	58	15/13,25	Al	1
1E5/50/6AN	47	63	15/13,25	Al	1

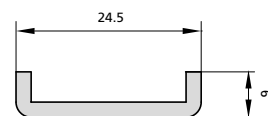

1E5/30/6U	23	39	15/13,25	Al	1
1E5/35/6U	28	44	15/13,25	Al	1
1E5/40/6U	33	49	15/13,25	Al	1
1E5/45/6U	38	54	15/13,25	Al	1
1E5/50/6U	43	59	15/13,25	Al	1



## MULTIPUNTO PALANCA BASCULANTE ENTRE EJES 85 mm.

## SERIE 2K5 DUE

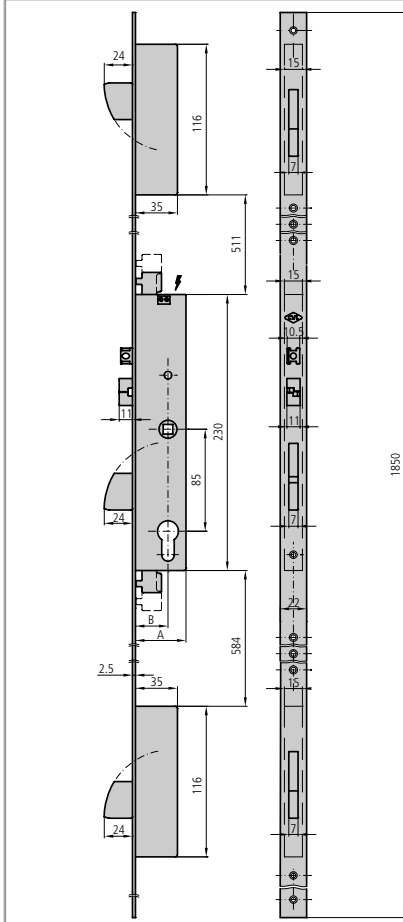

## CARACTERÍSTICAS

- Cerradura eléctrica 12V con apertura eléctrica automática con manilla o con cilindro
- Cerradura de 3 puntos con frente liso inox de 16 mm, 22 mm, 24 mm y U 24,5\*6
- Frente de 1850 mm de largo
- Sistema antitarjeta
- Compatible para AC y DC
- Mínimo esfuerzo para cierre de puerta
- Caja de 15 mm
- Cuadrado de 8 mm
- Escudo de seguridad pasante ref. BT1196/1N
- Cerraderos de serie según cerradura
- Tornillo de fijación de cilindro

## ACCESORIOS OPCIONALES

- Gama completa de cerraderos (ver páginas 44 - 51)
- Gama completa de cilindros (ver página 128 - 148)
- Frente de 2300 mm de largo opcional (serie 4K5)
- Frente de 1500 mm de largo opcional (serie 5K5)
- Conectores (ver página 56) CONECT01

## DESCRIPCIÓN

## REF.

MEDIDAS  
B A

## LEVA

ACABADOS  
FRENTE CILINDRO

## UDS

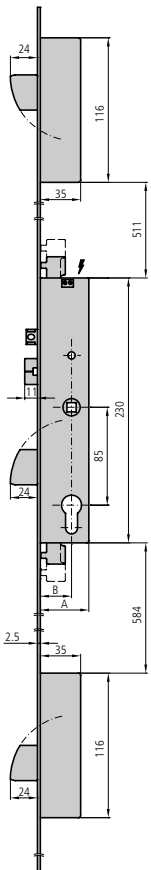

- Picaporte y palanca
- Cilindro no incluido
- Incluye cerradero ref. KCE1K5/6L
- 2 unidades alto/bajo: CE296S/6L

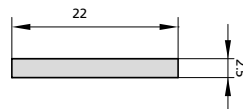

2K5/30/6L	27	42	15	Al	1
2K5/33/6L	30	43	13,25	Al	1
2K5/35/6L	32	47	15	Al	1

\* Otras medidas de frente consultar.



**PALANCA BASCULANTE ENTRE EJES 85 mm.**

**SERIE 1K5 DUE**

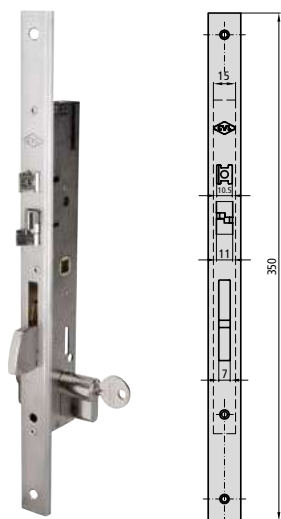

**CARACTERÍSTICAS**

- Cerradura eléctrica 12V con apertura eléctrica automática con manilla o con cilindro
- Sistema antitarjeta
- Compatible para AC y DC
- Mínimo esfuerzo para cierre de puerta
- Caja de 15 mm
- Cuadradillo de 8 mm
- 2 escudos de nylon ref. E51984
- Cerraderos de serie según cerradura
- Tornillo de fijación de cilindro
- 2 terminales de frente de nylon ref. EMB196 para frente liso (para frente de 22 mm.)

**ACCESORIOS OPCIONALES**

- Gama completa de cerraderos (ver páginas 44 - 51)
- Gama completa de cilindros (ver página 128 - 148)
- Conectores (ver página 56) CONECT01

DESCRIPCIÓN	REF.	MEDIDAS		LEVA	ACABADOS		UDS	
		B	A		FRENTE	CILINDRO		

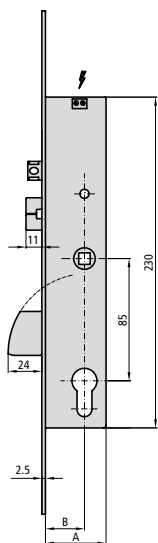

- Picaporte y palanca
- Cilindro no incluido
- Incluye cerradero Ref. KCE1K5/6L

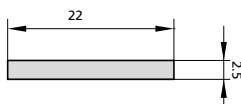

1K5/30/6	27	42	15	Al	1
1K5/33/6	30	43	13,25	Al	1
1K5/35/6	32	47	15	Al	1

\* Otras medidas de frente consultar.

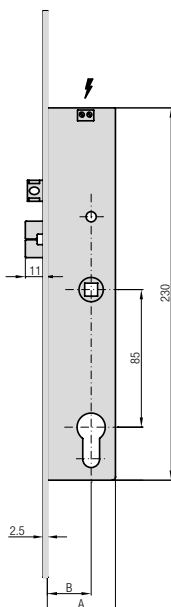

- Sólo picaporte
- Cilindro no incluido
- Incluye cerradero Ref. KCE1K5T/6L

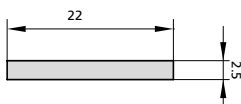

1K5T30/6	27	42	15	Al	1
1K5T33/6	30	43	13,25	Al	1
1K5T35/6	32	47	15	Al	1

\* Otras medidas de frente consultar.

## PUERTAS BATIENTES

## MULTIPUNTO PALANCA DESLIZANTE ENTRE EJES 92 mm.

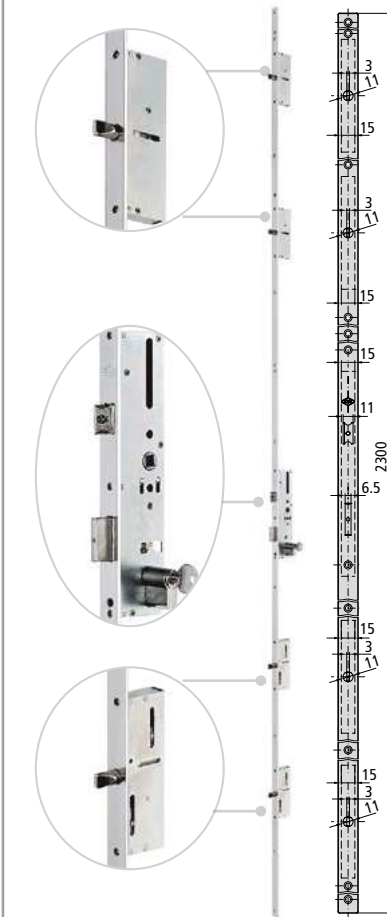
SERIE 4I25 **inve@se**

## CARACTERÍSTICAS

- Cerradura de 5 puntos con facilidad de cierre mediante manilla hacia arriba y bloqueo mediante llave
  - Frente liso inox de 22 mm
  - Frente de 2300 mm de largo
  - Picaporte de 11 mm reversible y regulable
  - Palanca central deslizante reforzada
  - Puntos alto y bajo con bulón
  - Caja cerrada de 15 mm
  - Cuadradillo de 8 mm
- Tornillo de fijación de cilindro

## ACCESORIOS OPCIONALES

- Gama completa de cerraderos (ver páginas 44 - 51)
- Gama completa de cilindros (ver página 128 - 148)
- Kit acople y punto de cierre adicional (ver página 10)

## DESCRIPCIÓN

## REF.

## MEDIDAS

## LEVA

## ACABADOS

## UDS

B A

FRENTE CILINDRO

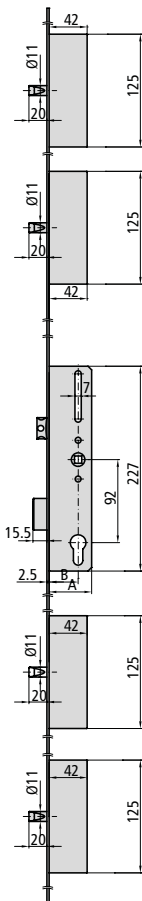
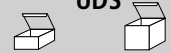

- Picaporte y palanca
- Cilindro no incluido

**Opciones de cerradero**  
(ver páginas 44 - 51)

REF.	B	A	LEVA	ACABADOS FRENTE CILINDRO	UDS
4I25/30/6L	27	42	15	Al	1
4I25/33/6L	30	45	15	Al	1
4I25/35/6L	32	47	15	Al	1
4I25/38/6L	35	50	15	Al	1
4I25/45/6L	42	57	15	Al	1
4I25/55/6L	52	67	15	Al	1

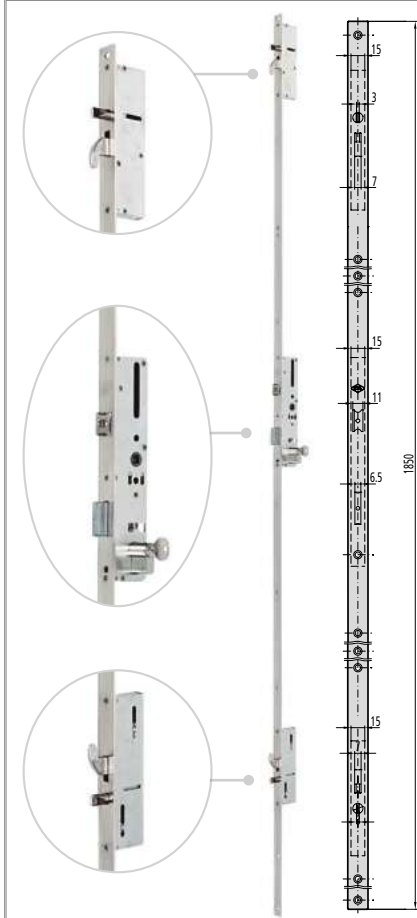
**PUERTAS BATIENTES**
**MULTIPUNTO PALANCA DESLIZANTE ENTRE EJES 92 mm.**
**SERIE 2I2GB *inve@se***

**CARACTERÍSTICAS**

- Cerradura multipunto con facilidad de cierre mediante manilla hacia arriba y bloqueo mediante llave
- Frente liso inox de 16 mm, 22 mm, 24 mm y U 24,5\*6
- Frente de 1850 mm de largo
- Picaporte de 11 mm reversible y regulable
- Palanca central deslizante reforzada
- Punto alto y bajo con gancho y bulón
- Caja cerrada de 15 mm
- Cuadradillo de 8 mm
- Tornillo de fijación de cilindro

**ACCESORIOS OPCIONALES**

- Gama completa de cerraderos (ver páginas 44 - 51)
- Gama completa de cilindros (ver página 128 - 148)
- Frente de 2300 mm de largo opcional (serie 4I2GB)
- Frente de 1500 mm de largo opcional (serie 5I2GB)

**DESCRIPCIÓN**
**REF.**
**MEDIDAS**  
**B      A**
**LEVA**
**ACABADOS**  
**FRENTE      CILINDRO**
**UDS**

- Picaporte y palanca
- Cilindro no incluido

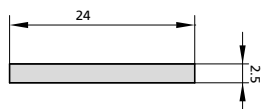
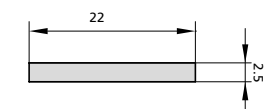
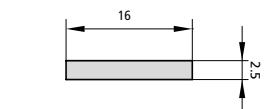
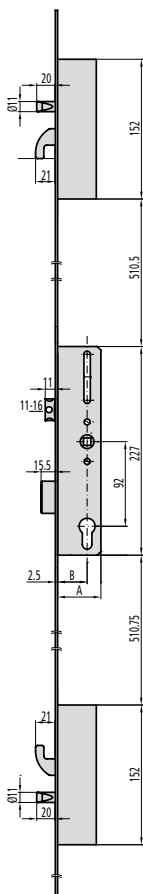
**Opciones de cerradero**  
 (ver páginas 44 - 51)

P2I2GB30/6	27	42	15	Al	1
P2I2GB33/6	30	45	15	Al	1
P2I2GB35/6	32	47	15	Al	1
P2I2GB38/6	35	50	15	Al	1
P2I2GB45/6	42	57	15	Al	1
P2I2GB55/6	52	67	15	Al	1
2I2GB30/6L	27	42	15	Al	1
2I2GB33/6L	30	45	15	Al	1
2I2GB35/6L	32	47	15	Al	1
2I2GB38/6L	35	50	15	Al	1
2I2GB45/6L	42	57	15	Al	1
2I2GB55/6L	52	67	15	Al	1
2I2GB30/6LAN	27	42	15	Al	1
2I2GB33/6LAN	30	45	15	Al	1
2I2GB35/6LAN	32	47	15	Al	1
2I2GB38/6LAN	35	50	15	Al	1
2I2GB45/6LAN	42	57	15	Al	1
2I2GB55/6LAN	52	67	15	Al	1
2I2GB30/6U	23	38	15	Al	1
2I2GB33/6U	26	41	15	Al	1
2I2GB35/6U	28	43	15	Al	1
2I2GB38/6U	31	46	15	Al	1
2I2GB45/6U	38	53	15	Al	1
2I2GB55/6U	48	63	15	Al	1



## PUERTAS BATIENTES

## MULTIPUNTO PALANCA DESLIZANTE ENTRE EJES 92 mm.

SERIE 2I2 **inve@se**

## CARACTERÍSTICAS

- Cerradura de 3 puntos con facilidad de cierre mediante manilla hacia arriba y bloqueo mediante llave
- Frente liso inox de 16 mm, 22 mm, 24 mm y U 24,5\*6
- Frente de 1850 mm de largo
- Picaporte de 11 mm reversible y regulable
- Palanca central deslizante reforzada
- Caja cerrada de 15 mm
- Cuadrado de 8 mm
- Tornillo de fijación de cilindro

## ACCESORIOS OPCIONALES

- Gama completa de cerraderos (ver páginas 44 - 51)
- Gama completa de cilindros (ver página 128 - 148)
- Frente de 2300 mm de largo opcional (serie 4I2)
- Frente de 1500 mm de largo opcional (serie 5I2)

## DESCRIPCIÓN

## REF.

MEDIDAS  
B A

## LEVA

ACABADOS  
FRENTE CILINDRO

## UDS

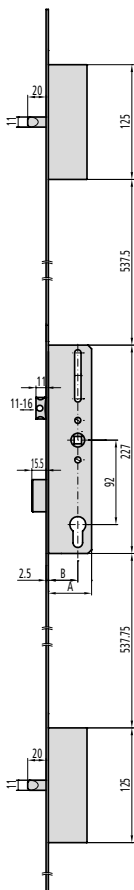

- Picaporte y palanca
- Cilindro no incluido

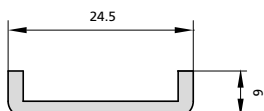
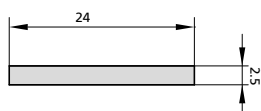
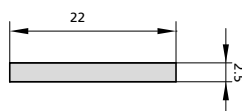
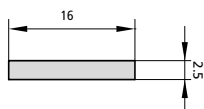
Opciones de cerradero  
(ver páginas 44 - 51)

P2I2/30/6	27	42	15	Al	1
P2I2/33/6	30	45	15	Al	1
P2I2/35/6	32	47	15	Al	1
P2I2/38/6	35	50	15	Al	1
P2I2/45/6	42	57	15	Al	1
P2I2/55/6	52	67	15	Al	1
2I2/30/6L	27	42	15	Al	1
2I2/33/6L	30	45	15	Al	1
2I2/35/6L	32	47	15	Al	1
2I2/38/6L	35	50	15	Al	1
2I2/45/6L	42	57	15	Al	1
2I2/55/6L	52	67	15	Al	1
2I2/30/6LAN	27	42	15	Al	1
2I2/33/6LAN	30	45	15	Al	1
2I2/35/6LAN	32	47	15	Al	1
2I2/38/6LAN	35	50	15	Al	1
2I2/45/6LAN	42	57	15	Al	1
2I2/55/6LAN	52	67	15	Al	1
2I2/30/6U	23	38	15	Al	1
2I2/33/6U	26	41	15	Al	1
2I2/35/6U	28	43	15	Al	1
2I2/38/6U	31	46	15	Al	1
2I2/45/6U	38	53	15	Al	1
2I2/55/6U	48	63	15	Al	1

MULTIPUNTO PALANCA DESLIZANTE

SERIE 3I2, 3I5 **inve@se**

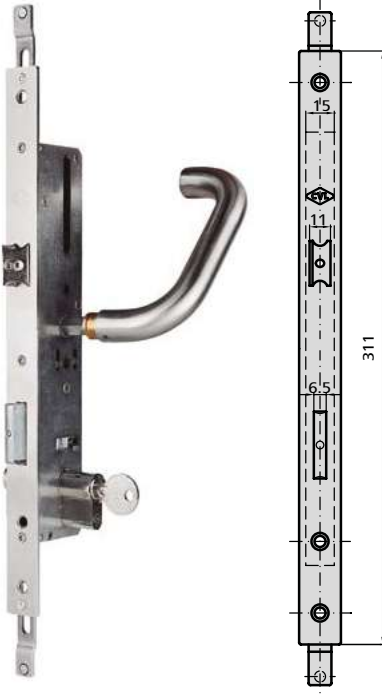

CARACTERÍSTICAS

- Cerradura multipunto central y alto/bajo con facilidad de cierre mediante manilla hacia arriba y bloqueo mediante llave
- Frente liso inox de 22 mm, 24 mm y U 24,5\*6
- Frente de 311 mm de largo
- Picaporte de 11 mm reversible y regulable
- Palanca central deslizante reforzada
- Caja cerrada de 15 mm
- Cuadradillo de 8 mm
- Entre ejes 85 mm (3I5) ó 92 mm (3I2)
- 2 escudos de nylon ref. ES1984
- Tornillo de fijación de cilindro

ACCESORIOS OPCIONALES

- Gama completa de cerraderos (ver páginas 44 - 51)
- Gama completa de cilindros (ver página 128 - 148)
- Accesorios 3I2 (ver página 52-55)

DESCRIPCIÓN	REF.	MEDIDAS		LEVA	ACABADOS		UDS	
		B	A		FRENTE	CILINDRO		

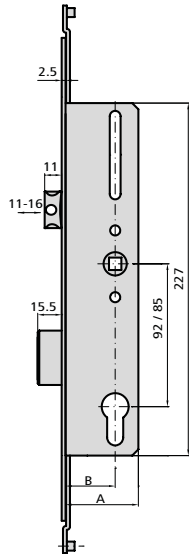

- Picaporte y palanca
- Cilindro no incluido

Opciones de cerradero (ver páginas 44 - 51)

3I2/30/6L	27	42	15	Al	1	10
3I2/33/6L	30	45	15	Al	1	10
3I2/35/6L	32	47	15	Al	1	10
3I2/38/6L	35	50	15	Al	1	10
3I2/45/6L	42	57	15	Al	1	10
3I2/55/6L	52	67	15	Al	1	10
3I5/30/6L	27	42	15	Al	1	10
3I5/33/6L	30	45	15	Al	1	10
3I5/35/6L	32	47	15	Al	1	10
3I5/38/6L	35	50	15	Al	1	10
3I5/45/6L	42	57	15	Al	1	10
3I5/55/6L	52	67	15	Al	1	10

\* Otras medidas de frente consultar.

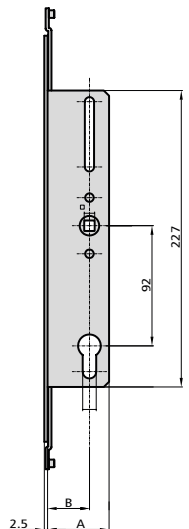

3I2F45/6L	42	57	15	Al	1	10
-----------	----	----	----	----	---	----

## PUERTAS BATIENTES

## CERRADURA ANTIPÁNICO PALANCA DESLIZANTE

## SERIES 615, 612

alupanic



## CARACTERÍSTICAS

- Cerradura con función antipánico para puertas de aluminio y metálicas
- Sistema antipánico reversible
- Frente inox. de 22 mm
- Picaporte reversible de 11 mm
- Picaporte regulable, excepto en entrada de 25 mm
- Caja de 15 mm
- Cuadradillo de 8 mm
- Operado mediante llave y tirador desde el exterior
- Tornillo de fijación de cilindro
- Entre ejes 85 mm (615) ó 92 mm (612)

## ACCESORIOS OPCIONALES

- Gama completa de cerraderos (ver páginas 44 - 51)
- Gama completa de cilindros (ver página 128 - 148)

## DESCRIPCIÓN

## REF.

MEDIDAS  
B A

## LEVA

ACABADOS  
FRENTE CILINDRO

## UDS

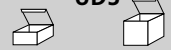

- Picaporte y palanca
- Cilindro no incluido
- Cerradura con nueca partida

- Opciones de cerradero (ver páginas 44-51)
- Opción de cerradero eléctrico (ver página 52)

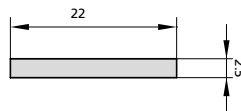

615/25/6	22	37	15	Al	1	20
615/30/6	27	42	15	Al	1	20
615/35/6	32	47	15	Al	1	20
612/25/6	22	37	15	Al	1	20
612/30/6	27	42	15	Al	1	20
612/35/6	32	47	15	Al	1	20

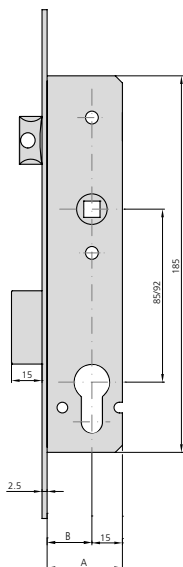



CARACTERÍSTICAS

- Cerradura con función antipánico para puertas de aluminio y metálicas
- Sistema antipánico reversible
- Frente inox de 22 mm
- Picaporte reversible de 11 mm
- Picaporte regulable, excepto en entrada de 25 mm
- Caja de 15 mm
- Cuadradillo de 8 mm
- Operado mediante llave y manilla desde el exterior. La llave bloquea o desbloquea la manilla
- Tornillo de fijación de cilindro
- Entre ejes 85 mm (615E) ó 92 mm (612E)

ACCESORIOS OPCIONALES

- Gama completa de cerraderos (ver páginas 44 - 51)
- Gama completa de cilindros (ver página 128 - 148)

DESCRIPCIÓN

REF.

MEDIDAS  
B A

LEVA

ACABADOS  
FRETE CILINDRO

UDS



- Picaporte y palanca
- Cilindro no incluido
- Cerradura con nueca partida

- Opciones de cerradero (ver páginas 44-51)
- Opción de cerradero eléctrico (ver página 52)

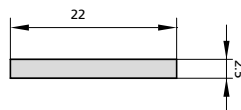

615E/25/6	22	37	15	Al	1	20
615E/30/6	27	42	15	Al	1	20
615E/35/6	32	47	15	Al	1	20
612E/25/6	22	37	15	Al	1	20
612E/30/6	27	42	15	Al	1	20
612E/35/6	32	47	15	Al	1	20

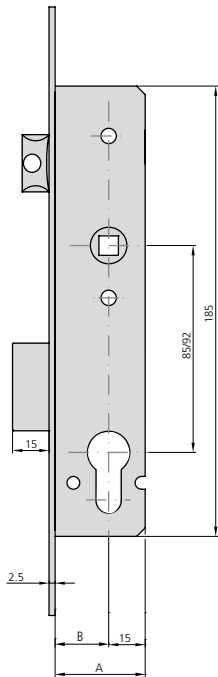

## PUERTAS BATIENTES

## PALANCA DESLIZANTE ENTRE EJES 85 mm.

## SERIE 184

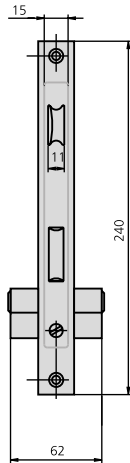

## CARACTERÍSTICAS

- Frente de 22 mm ó 24 mm
- Picaporte reversible de 11 mm
- Caja de 15 mm
- Cuadradillo de 8 mm
- 2 escudos de nylon ref. ES1984
- 2 terminales de frente de nylon ref. EMB196 (para frente de 22 mm)
- Tornillo de fijación de cilindro
- Según norma UNE-EN 12209:2004

## ACCESORIOS OPCIONALES

- Gama completa de cerraderos (ver páginas 44 - 51)
- Gama completa de cilindros (ver página 128 - 148)
- Kit para adaptación a condensa (ver página 167)

## DESCRIPCIÓN

## REF.

## MEDIDAS

## LEVA

## ACABADOS

## UDS

B A

FRENTE CILINDRO

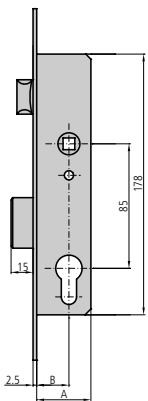

- Picaporte y palanca
- Cilindros de leva larga 5982/2525/4 o de leva corta 5990/2525/4

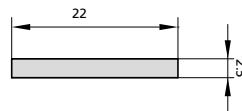
Opciones de cerradero  
(ver páginas 44 - 51)Opción cerraderos  
eléctricos  
(ver página 52)

184/21/0	18	31	13,25	HN	CN	1	20
184/21/6D	18	31	15	Al	CN	1	20
184/23/0	20	33	13,25	HN	CN	1	20
184/23/6	20	33	13,25	Al	CN	1	20
184/25/0	22	37	15	HN	CN	1	20
184/25/6	22	37	15	Al	CN	1	20
184/28/0	25	38	13,25	HN	CN	1	20
184/28/6	25	38	13,25	Al	CN	1	20
184/30/0	27	42	15	HN	CN	1	20
184/30/6	27	42	15	Al	CN	1	20
184/33/0	30	43	13,25	HN	CN	1	20
184/33/6	30	43	13,25	Al	CN	1	20
184/35/0	32	47	15	HN	CN	1	20
184/35/6	32	47	15	Al	CN	1	20

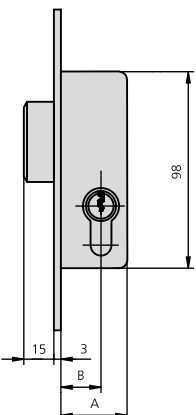

- Sólo palanca
- Cilindros de leva larga 5982/2525/4 o de leva corta 5990/2525/4

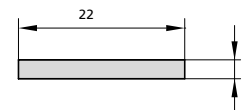
Opciones de cerradero  
(ver páginas 44 - 51)

184A23/6	20	33	13,25	Al	CN	1	30
184A25/6	22	37	15	Al	CN	1	30
184A28/6	25	38	13,25	Al	CN	1	30
184A30/6	27	42	15	Al	CN	1	30
184A33/6	30	43	13,25	Al	CN	1	30
184A35/6	32	47	15	Al	CN	1	30



DESCRIPCIÓN	REF.	MEDIDAS		LEVA	ACABADOS		UDS	
		B	A		FRENTE	CILINDRO		

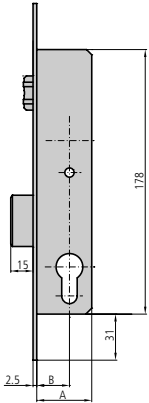
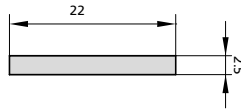

• Rodillo vaivén regulable y palanca	184V23/6	20	33	13,25	Al	CN	1	20
	184V25/6	22	37	15	Al	CN	1	20
• Cilindros de leva larga 5982/2525/4 o de leva corta 5990/2525/4	184V28/6	25	38	13,25	Al	CN	1	20
	184V30/6	27	42	15	Al	CN	1	20
	184V33/6	30	43	13,25	Al	CN	1	20
<b>Opciones de cerradero</b> (ver páginas 44 - 51)	184V35/6	32	47	15	Al	CN	1	20



**PUERTAS BATIENTES**
**MULTIPUNTO PALANCA BASCULANTE ENTRE EJES 85 mm.**
**SERIE 296**

DESCRIPCIÓN	REF.	MEDIDAS		LEVA	ACABADOS		UDS
		B	A		FRENTE	CILINDRO	
	296A25/6L	22	37	15	Al		1
	296A28/6L	25	38	13,25	Al		1
	296A30/6L	27	42	15	Al		1
	296A33/6L	30	43	13,25	Al		1
	296A35/6L	32	47	15	Al		1
	296A38/6L	35	48	13,25	Al		1
	296A25/6LAN	22	37	15	Al		1
	296A28/6LAN	25	38	13,25	Al		1
	296A30/6LAN	27	42	15	Al		1
	296A33/6LAN	30	43	13,25	Al		1
	296A35/6LAN	32	47	15	Al		1
	296A38/6LAN	35	48	13,25	Al		1
	296A25/6U	18	33	15	Al		1
	296A30/6U	23	38	15	Al		1
	296A35/6U	28	43	15	Al		1

• Sólo palanca  
 • Cilindro no incluido  
**Opciones de cerradero**  
 (ver páginas 44 - 51)

	296V25/6L	22	37	15	Al		1
	296V28/6L	25	38	13,25	Al		1
	296V30/6L	27	42	15	Al		1
	296V33/6L	30	43	13,25	Al		1
	296V35/6L	32	47	15	Al		1
	296V38/6L	35	48	13,25	Al		1
	296V25/6LAN	22	37	15	Al		1
	296V28/6LAN	25	38	13,25	Al		1
	296V30/6LAN	27	42	15	Al		1
	296V33/6LAN	30	43	13,25	Al		1
	296V35/6LAN	32	47	15	Al		1
	296V38/6LAN	35	48	13,25	Al		1
	296V25/6U	18	33	15	Al		1
	296V30/6U	23	38	15	Al		1
	296V35/6U	28	43	15	Al		1

• Rodillo vaivén regulable y palanca  
 • Cilindro no incluido  
**Opciones de cerradero**  
 (ver páginas 44 - 51)

## PUERTAS BATIENTES

## PALANCA BASCULANTE ENTRE EJES 85 mm.

## SERIE 196

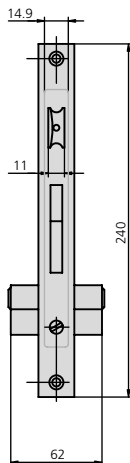

## CARACTERÍSTICAS

- Frente inox de 22 mm o 24 mm o frente U de 24,5 x 6
- Picaporte reversible de 11 mm
- Picaporte regulable excepto en entrada 25 mm y 28 mm
- Caja de 15 mm
- Cuadradillo de 8 mm
- 2 escudos de nylon ref. ES1984
- 2 terminales de frente de nylon ref. EMB196 (para frente de 22 mm)
- Tornillo de fijación de cilindro

## ACCESORIOS OPCIONALES

- Gama completa de cerraderos (ver páginas 44 - 51)
- Gama completa de cerraderos (ver página 128 - 148)
- Escudo de seguridad pasante BTI296/1N (ver página 56)
- Kit para adaptación a condensa (ver página 167)

## DESCRIPCIÓN

## REF.

## MEDIDAS

## LEVA

## ACABADOS

## UDS

B A

FRENTE CILINDRO

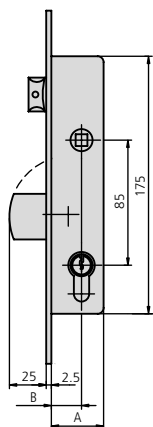
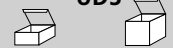

- Picaporte y palanca
- Cilindro de leva larga 5982/2525/4 o de leva corta 5990/2525/4

**Opciones de cerradero**  
(ver páginas 44 - 51)

**Opción cerradero eléctrico**  
(ver página 52)

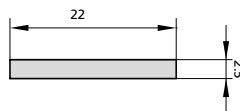

196/25/6	22	37	15	AI	CN	1	20
196/28/6	25	38	13,25	AI	CN	1	20
196/30/6	27	42	15	AI	CN	1	20
196/33/6	30	43	13,25	AI	CN	1	20
196/35/6	32	47	15	AI	CN	1	20
196/38/6	35	48	13,25	AI	CN	1	20

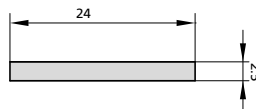

196/25/6AN	22	37	15	AI	CN	1	20
196/28/6AN	25	38	13,25	AI	CN	1	20
196/30/6AN	27	42	15	AI	CN	1	20
196/33/6AN	30	43	13,25	AI	CN	1	20
196/35/6AN	32	47	15	AI	CN	1	20
196/38/6AN	35	48	13,25	AI	CN	1	20

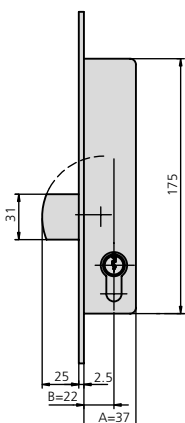

- Sólo palanca
- Cilindro de leva larga 5982/2525/4 o de leva corta 5990/2525/4

**Opciones de cerradero**  
(ver páginas 44 - 51)

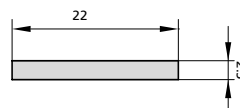

196A25/6	22	37	15	AI	CN	1	20
196A28/6	25	38	13,25	AI	CN	1	20
196A30/6	27	42	15	AI	CN	1	20
196A33/6	30	43	13,25	AI	CN	1	20
196A35/6	32	47	15	AI	CN	1	20
196A38/6	35	48	13,25	AI	CN	1	20

**PUERTAS BATIENTES**
**PALANCA BASCULANTE ENTRE EJES 85 mm.**
**SERIE 196**

DESCRIPCIÓN	REF.	MEDIDAS		LEVA	ACABADOS		UDS	
		B	A		FRENTE	CILINDRO		
<ul style="list-style-type: none"> <li>Sólo picaporte y medio cilindro</li> <li>Cilindro 5982T40/4</li> </ul> <p><b>Opción cerradero eléctrico</b> (ver página 52)</p>	196T23/6	20	33	13,25	Al	CN	1	20
	196T25/6	22	37	15	Al	CN	1	20
	196T28/6	25	38	13,25	Al	CN	1	20
	196T30/6	27	42	15	Al	CN	1	20
	196T33/6	30	43	13,25	Al	CN	1	20
	196T35/6	32	47	15	Al	CN	1	20
	196T38/6	35	48	13,25	Al	CN	1	20
	<ul style="list-style-type: none"> <li>Sólo picaporte y sin cilindro</li> </ul> <p><b>Opciones de cerradero</b> (ver páginas 44 - 51)</p>	196R23/6	20	33		Al	CN	2
196R25/6		22	37		Al	CN	2	20
196R28/6		25	38		Al	CN	2	20
196R30/6		27	42		Al	CN	2	20
196R33/6		30	43		Al	CN	2	20
196R35/6		32	47		Al	CN	2	20
196R38/6		35	48		Al	CN	2	20
<ul style="list-style-type: none"> <li>Sólo vaivén</li> </ul> <p><b>Opciones de cerradero</b> (ver páginas 44 - 51)</p>	196RV/6		33		Al	CN	2	20
<ul style="list-style-type: none"> <li>Rodillo vaivén regulable y palanca</li> <li>Cilindro de leva larga 5982/2525/4 o de leva corta 5990/2525/4</li> </ul> <p><b>Opciones de cerradero</b> (ver páginas 44 - 51)</p>	196V25/6	22	37	15	Al	CN	1	20
	196V28/6	25	38	13,25	Al	CN	1	20
	196V30/6	27	42	15	Al	CN	1	20
	196V33/6	30	43	13,25	Al	CN	1	20
	196V35/6	32	47	15	Al	CN	1	20
	196V38/6	35	48	13,25	Al	CN	1	20



## PUERTAS BATIENTES

## PALANCA GANCHO ENTRE EJES 85 mm.

## SERIE 197

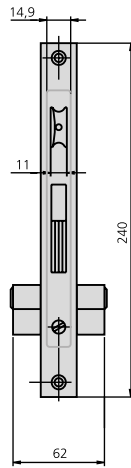

## CARACTERÍSTICAS

- Frente inox de 22 mm
- Picaporte reversible de 11 mm
- Picaporte regulable excepto en entrada 25 mm y 28 mm
- Caja de 15 mm
- Cuadradillo de 8 mm
- 2 escudos de nylon ref. E51984
- 2 terminales de frente de nylon ref. EMB196 (para frente de 22 mm)
- Tornillo de fijación de cilindro

## ACCESORIOS OPCIONALES

- Gama completa de cerraderos (ver páginas 44 - 51)
- Gama completa de cilindros (ver página 128 - 148)
- Escudo de seguridad pasante BTI296/1N (ver página 56)

## DESCRIPCIÓN

## REF.

MEDIDAS  
B A

## LEVA

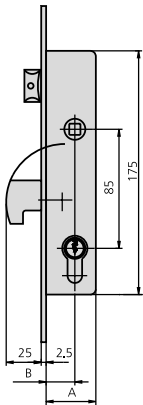
ACABADOS  
FRENTE CILINDROUDS  

- Picaporte y palanca gancho
- Cilindro de leva larga 5982/2525/4 o de leva corta 5990/2525/4

**Opciones de cerradero**  
(ver páginas 44 - 51)

197/25/6	22	37	15	AI	CN	1	20
197/28/6	25	38	13,25	AI	CN	1	20
197/30/6	27	42	15	AI	CN	1	20
197/33/6	30	43	13,25	AI	CN	1	20
197/35/6	32	47	15	AI	CN	1	20
197/38/6	35	48	13,25	AI	CN	1	20

PALANCA DESLIZANTE ENTRE EJES 92 mm.

SERIE 192

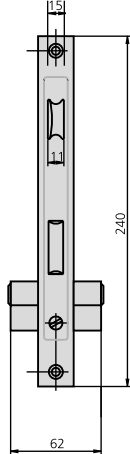

CARACTERÍSTICAS

- Frente inox de 16 mm, 22 mm o 24 mm
- Picaporte reversible de 11 mm
- Caja de 15 mm
- Cuadradillo de 8 mm
- Según norma UNE-EN 12209:2004
- 2 escudos de nylon ref. ES1984
- Tornillo de fijación de cilindro

ACCESORIOS OPCIONALES

- Gama completa de cerraderos (ver páginas 44 - 51)
- Gama completa de cilindros (ver página 128 - 148)
- Kit para adaptación a condensa (ver página 167)

DESCRIPCIÓN	REF.	MEDIDAS		LEVA	ACABADOS		UDS	
		B	A		FRENTE	CILINDRO		

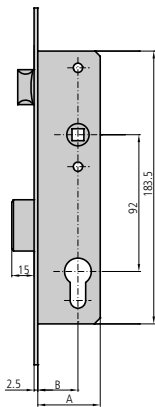

- Picaporte y palanca
- No incluye cilindro

Opciones de cerradero (ver páginas 44 - 51)

Opción cerradero eléctrico (ver página 52)

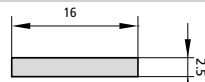

P192/25/6	22	37	15	Al	CN	1	20
P192/30/6	27	42	15	Al	CN	1	20
P192/35/6	32	47	15	Al	CN	1	20

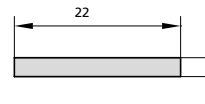

192/25/6	22	37	15	Al	CN	1	20
192/30/6	27	42	15	Al	CN	1	20
192/35/6	32	47	15	Al	CN	1	20

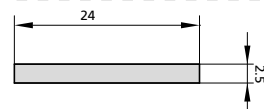

192/25/6AN	22	37	15	Al	CN	1	20
192/30/6AN	27	42	15	Al	CN	1	20
192/35/6AN	32	47	15	Al	CN	1	20

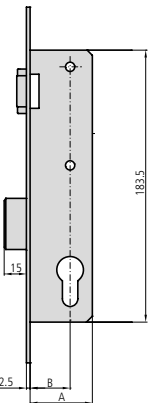

- Rodillo vaivén regulable y palanca
- No incluye cilindro

Opciones de cerradero (ver páginas 44 - 51)

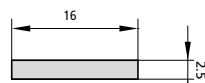

P192V25/6	22	37	15	Al	CN	1	20
P192V30/6	27	42	15	Al	CN	1	20
P192V35/6	32	47	15	Al	CN	1	20

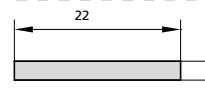

192V25/6	22	37	15	Al	CN	1	20
192V30/6	27	42	15	Al	CN	1	20
192V35/6	32	47	15	Al	CN	1	20



192V25/6AN	22	37	15	Al	CN	1	20
192V30/6AN	27	42	15	Al	CN	1	20
192V35/6AN	32	47	15	Al	CN	1	20

## PUERTAS BATIENTES

## MULTIPUNTO PALANCA BASCULANTE ENTRE EJES 92 mm.

## SERIE 294N



## CARACTERÍSTICAS

- Frente liso inox de 1850x22 mm o 1850x24 mm o frente U de 1850x24,5x6
- Picaporte reversible de 11 mm
- Picaporte regulable
- Caja de 15 mm
- Cuadradillo de 8 mm
- Tornillo de fijación de cilindro

## ACCESORIOS OPCIONALES

- Gama completa de cerraderos (ver páginas 44 - 51)
- Gama completa de cilindros (ver página 128 - 148)
- Frente de 2300 mm de largo opcional (serie 494N)
- Frente de 1500 mm de largo opcional (serie 594N)
- Kit vaivén para sustituir picaporte (ref. CV1E5) (ver página 56)

## DESCRIPCIÓN

## REF.

MEDIDAS  
B A

## LEVA

ACABADOS  
FRENTE CILINDRO

## UDS

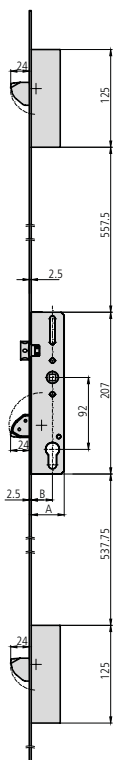

- Picaporte y palanca
- Cilindro no incluido

**Opciones de cerradero**  
(ver páginas 44 - 51)

**Opción cerradero eléctrico**  
(ver página 52)

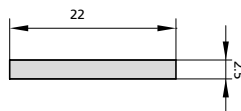

294N/30/6L	27	42	15	Al	1
294N/35/6L	32	47	15	Al	1

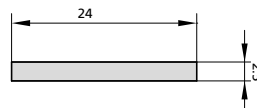

294N/30/6LAN	27	42	15	Al	1
294N/35/6LAN	32	47	15	Al	1

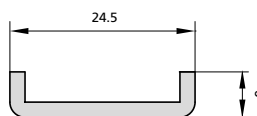

294N/30/6U	23	38	15	Al	1
294N/35/6U	28	43	15	Al	1

DESCRIPCIÓN	REF.	MEDIDAS		LEVA	ACABADOS		UDS
		B	A		FRENTE	CILINDRO	

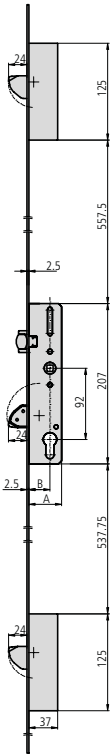

- Rodillo vaivén regulable de nylon y palanca
- Cilindro no incluido

**Opciones de cerradero**  
(ver páginas 44 - 51)

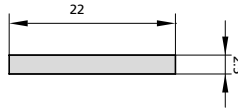

294NV30/6L	27	42	15	Al	1
294NV35/6L	32	47	15	Al	1

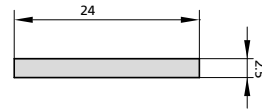

294NV30/6LAN	27	42	15	Al	1
294NV35/6LAN	32	47	15	Al	1

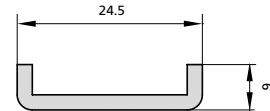

294NV30/6U	23	38	15	Al	1
294NV35/6U	28	43	15	Al	1

## PUERTAS BATIENTES

## PALANCA BASCULANTE ENTRE EJES 92 mm.

## SERIE 194

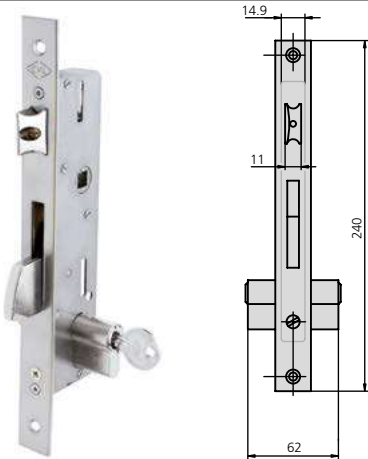

## CARACTERÍSTICAS

- Frente liso inox de 22 mm o 24 mm ó frente inox en U de 24,5x6
- Picaporte reversible de 11 mm
- Picaporte regulable excepto en entrada 25 mm
- Caja de 15 mm
- Cuadradillo de 8 mm
- 2 escudos de nylon ref. ES1984
- Tornillo de fijación de cilindro

## ACCESORIOS OPCIONALES

- Gama completa de cerraderos (ver páginas 44 - 51)
- Gama completa de cilindros (ver página 128 - 148)
- Escudo de seguridad pasante BTI296 (ver página 56)
- Kit para adaptación a condensa (ver página 167)

## DESCRIPCIÓN

## REF.

## MEDIDAS

## LEVA

## ACABADOS

## UDS

B A

FRENTE CILINDRO

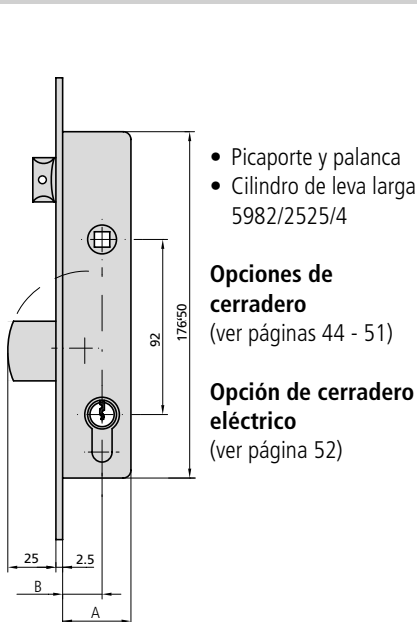
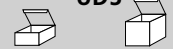

- Picaporte y palanca
- Cilindro de leva larga 5982/2525/4

**Opciones de cerradero**  
(ver páginas 44 - 51)

**Opción de cerradero eléctrico**  
(ver página 52)

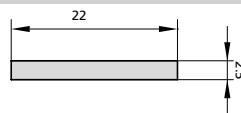

194/25/6	22	37	15	Al	CN	1	20
194/30/6	27	42	15	Al	CN	1	20
194/35/6	32	47	15	Al	CN	1	20

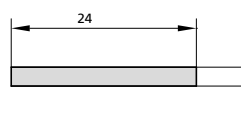

194/25/6AN	22	37	15	Al	CN	1	20
194/30/6AN	27	42	15	Al	CN	1	20
194/35/6AN	32	47	15	Al	CN	1	20

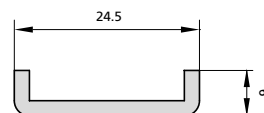

194/25/6U	18	33	15	Al U	CN	1	20
194/30/6U	23	38	15	Al U	CN	1	20
194/35/6U	28	43	15	Al U	CN	1	20

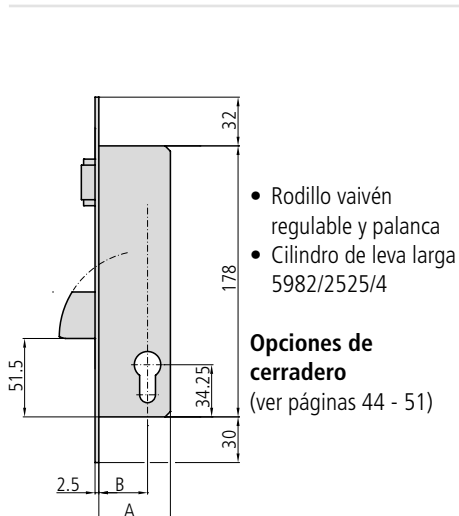

- Rodillo vaivén regulable y palanca
- Cilindro de leva larga 5982/2525/4

**Opciones de cerradero**  
(ver páginas 44 - 51)

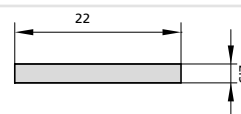

194RV25/6	22	37	15	Al	CN	1	20
194RV30/6	27	42	15	Al	CN	1	20
194RV35/6	32	47	15	Al	CN	1	20



194RV25/6AN	22	37	15	Al	CN	1	20
194RV30/6AN	27	42	15	Al	CN	1	20
194RV35/6AN	32	47	15	Al	CN	1	20

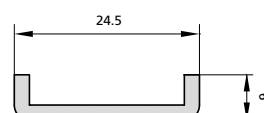

194RV25/6U	18	33	15	Al U	CN	1	20
194RV30/6U	23	38	15	Al U	CN	1	20
194RV35/6U	28	43	15	Al U	CN	1	20

PALANCA BASCULANTE ENTRE EJES 92 mm

SERIE 194F

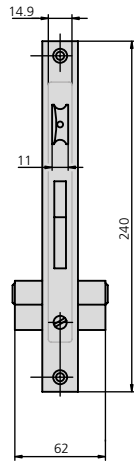

CARACTERÍSTICAS

- Cerradura para puertas de aluminio
- Frente liso inox de 22 mm
- **Picaporte de acero** reversible de 11 mm
- Picaporte regulable
- Caja de 15 mm
- Cuadradillo de 8 mm
- 2 escudos de nylon ref. ES1984
- Tornillo de fijación de cilindro

ACCESORIOS OPCIONALES

- Gama completa de cerraderos (ver páginas 44 - 51)
- Gama completa de cilindros (ver página 128 - 148)
- Escudo de seguridad pasante BTI296 (ver página 56)

DESCRIPCIÓN	REF.	MEDIDAS		LEVA	ACABADOS		UDS	
		B	A		FRENTE	CILINDRO		

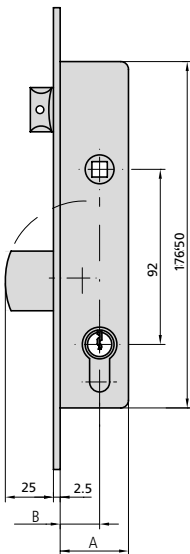

- Picaporte y palanca
- No incluye cilindro

**Opciones de cerradero**  
(ver páginas 44 - 51)

**Opción de cerradero eléctrico**  
(ver página 52)

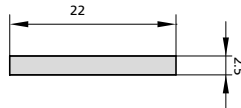

194F/30/6SC	27	42	15	Al	CN	1	20
194F/35/6SC	32	47	15	Al	CN	1	20

## PUERTAS BATIENTES

## ACCESORIOS

## CERRADEROS

UDS



DESCRIPCIÓN

REF.

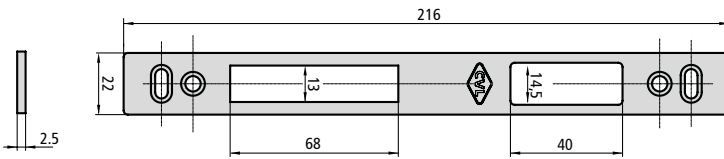
APLICABLE A  
CERRADURAS

- Cerradero fijo de hierro niquelado CE184/0L
- Cerradero fijo de acero inoxidable CE184/6L

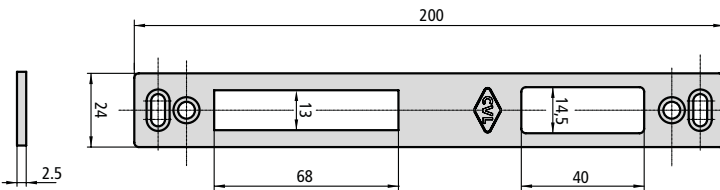

- Cerradero fijo de hierro niquelado CE184/0LAN
- Cerradero fijo de acero inoxidable CE184/6LAN

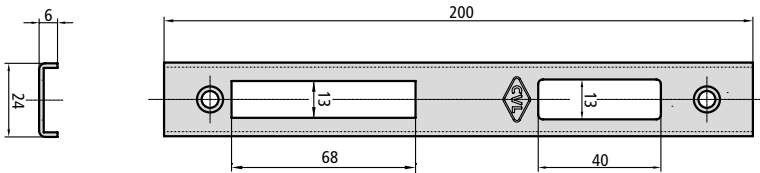

- Cerradero fijo de acero inoxidable CE184/6U

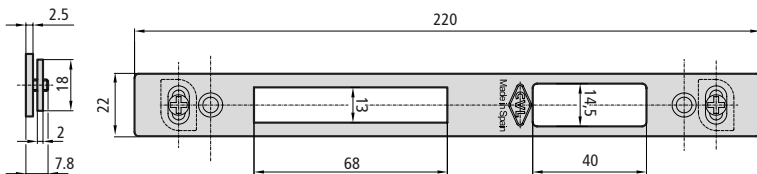

- Cerradero regulable de acero inoxidable CE184/6LR

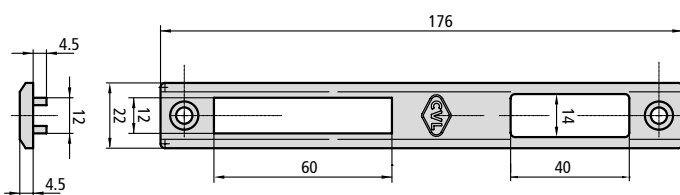

- Cerradero fijo metálico negro CE184/1N

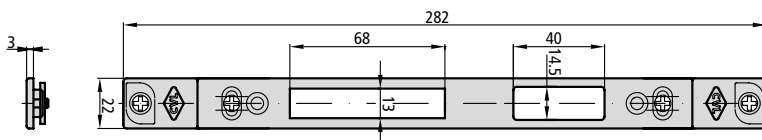

- Cerradero regulable metálico negro CE184/1NR

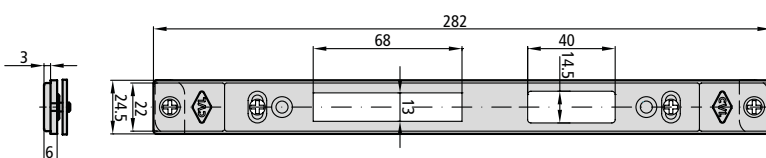



- Cerradero regulable metálico negro con suplemento CE184/1NRS

184, 184C, 184V,  
192, 192C, 192V, 1E5,  
central 2E5, 1E2,  
central 2E2, 2E2GB,  
615, 615E,  
2I2, 2I2GB, 3I2,  
2A2 central



ACCESORIOS

CERRADEROS

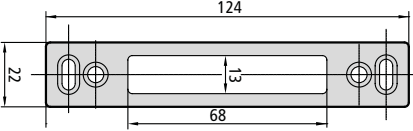
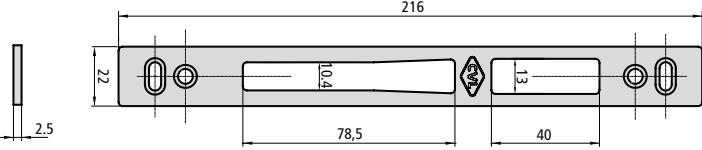
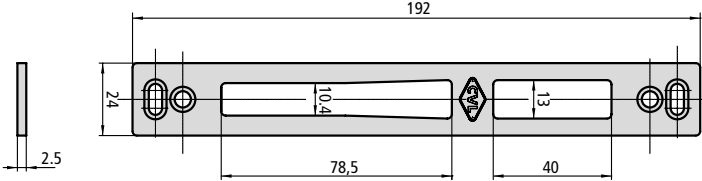
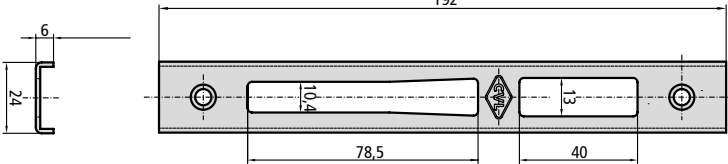
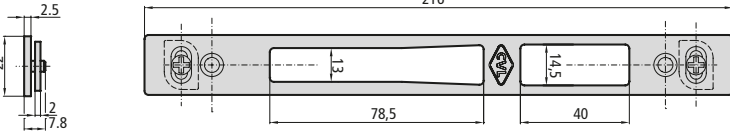
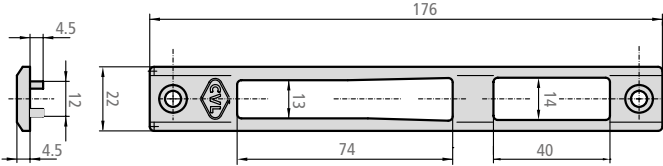
DESCRIPCIÓN	REF.	APLICABLE A CERRADURAS	UDS  
 <p>• Cerradero fijo de acero inoxidable</p>	CE184A/6L	184A	
 <p>• Cerradero fijo de acero inoxidable</p>	CE196/6L		
 <p>• Cerradero fijo de acero inoxidable</p>	CE196/6LAN		
 <p>• Cerradero fijo de acero inoxidable con levas</p>	CE196/6U	196, 196C, 196V, 197, 194, 194C, 194F, 194V, central 296, 296V, 396, 496, 496V, 596, 596V, 294N, 294NV, 494N, 494NV	
 <p>• Cerradero regulable de acero inoxidable con levas</p>	CE196/6LR		
 <p>• Cerradero fijo metálico negro</p>	CE196/1N		

## PUERTAS BATIENTES

## ACCESORIOS

## CERRADEROS

UDS



DESCRIPCIÓN

REF.

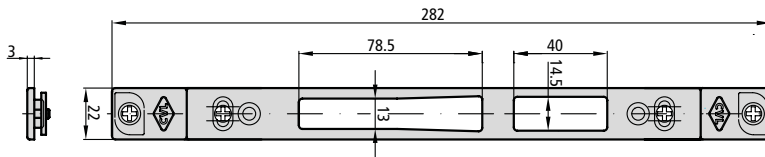
APLICABLE A  
CERRADURAS

- Cerradero regulable metálico negro CE196/1NR

196, 196C, 196V, 197,  
194, 194C, 194F, 194V,  
central 296, 296V, 396,  
496, 496V, 596, 596V,  
294N, 294NV, 494N,  
494NV

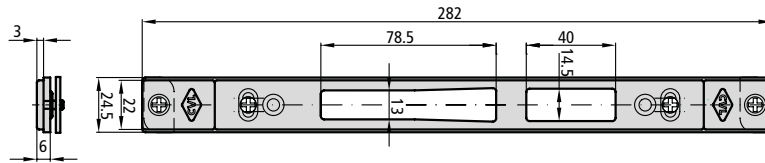

- Cerradero regulable metálico negro con suplemento CE196/1NRS

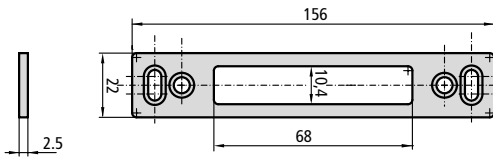

- Cerradero fijo de acero inoxidable para solo palanca CE296S/6L

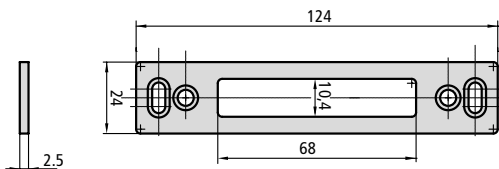

- Cerradero fijo de acero inoxidable para solo palanca CE296S/6LAN

196A, 296A, 496A,  
596A, 294A, 494A,  
suplementos alto/bajo de  
las series 296, 496, 596,  
294N, 494N, 2E5, 2E2,  
2K2, 2K5

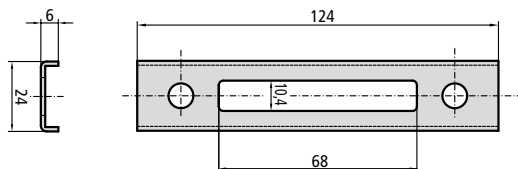

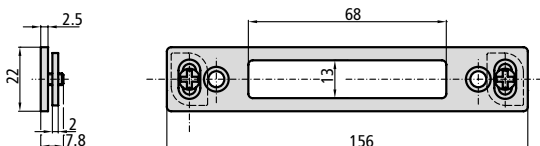

- Cerradero fijo de acero inoxidable para solo palanca CE296S/6U



- Cerradero regulable de acero inoxidable con levas CE296S/6LR

**PUERTAS BATIENTES**
**ACCESORIOS**
**CERRADEROS**

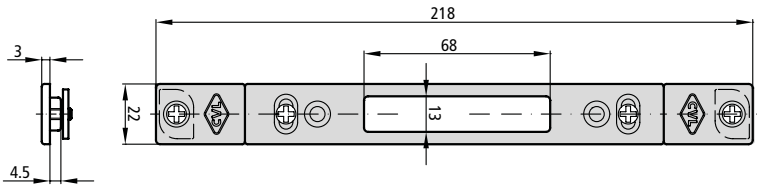
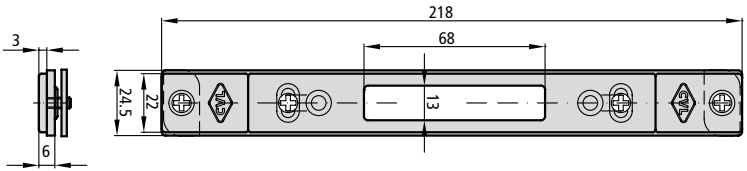
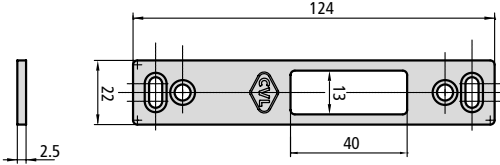
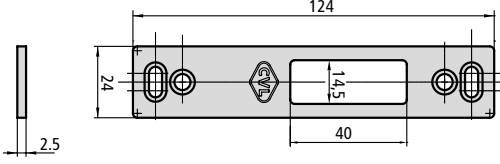
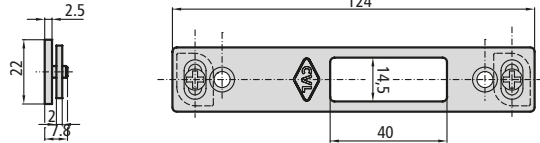
DESCRIPCIÓN	REF.	APLICABLE A CERRADURAS	UDS  
 <p>• Cerradero regulable metálico negro</p>	CE296S/1NR	196A, 296A, 496A, 596A, 294A, 494A, suplementos alto/bajo de las series 296, 496, 596, 294N, 494N, 2E5, 2E2, 2K2 2K5	
 <p>• Cerradero regulable metálico negro con suplemento</p>	CE296S/1NRS		
 <p>• Cerradero fijo de acero inoxidable para solo picaporte</p>	CE196R/6L	196R, 196RV, 196T, 194T	
 <p>• Cerradero fijo de acero inoxidable para solo picaporte</p>	CE196R/6LAN		
 <p>• Cerradero regulable de acero inoxidable con levas</p>	CE196R/6LR		

## PUERTAS BATIENTES

## ACCESORIOS

## CERRADEROS

UDS



DESCRIPCIÓN

REF.

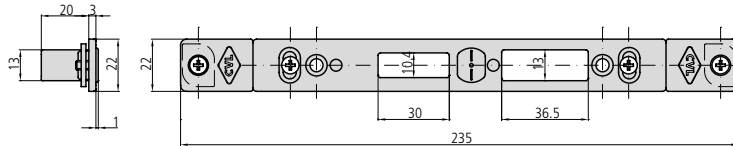
APLICABLE A  
CERRADURAS

- Cerradero regulable metálico negro

CE2A2S/1NR

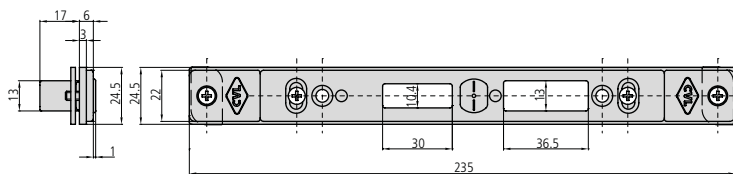

- Cerradero regulable metálico negro con suplemento

CE2A2S/1NRS

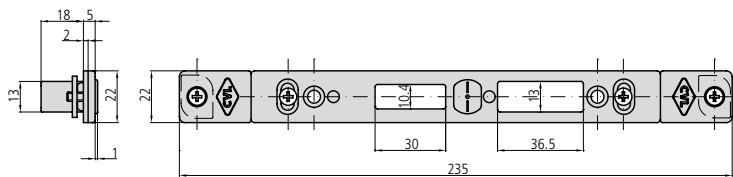

- Cerradero regulable metálico negro con suplemento de 22mm\*2mm

CE2A2S/1N22

2A2 alto / bajo

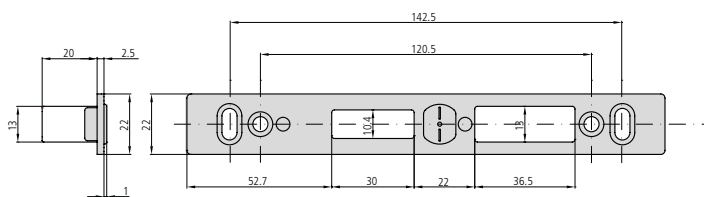

- Cerradero fijo de acero inoxidable

CE2A2S/6L

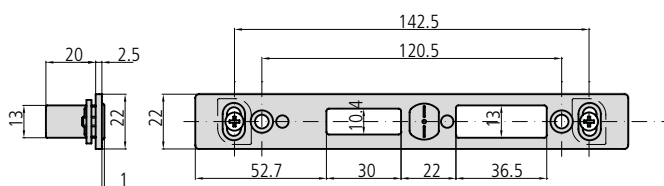



- Cerradero regulable de acero inoxidable con levas

CE2A2S/6LR

ACCESORIOS

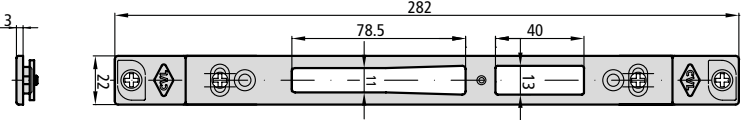
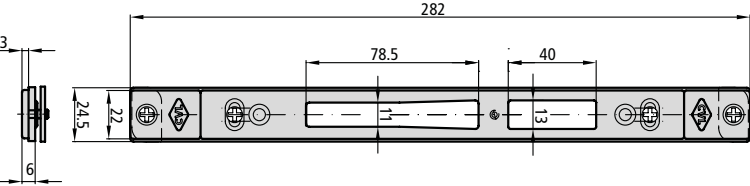
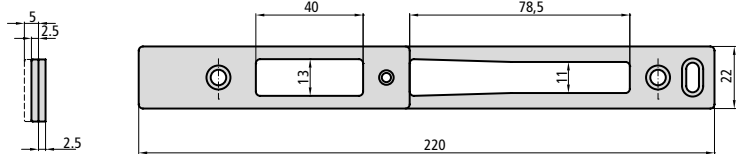
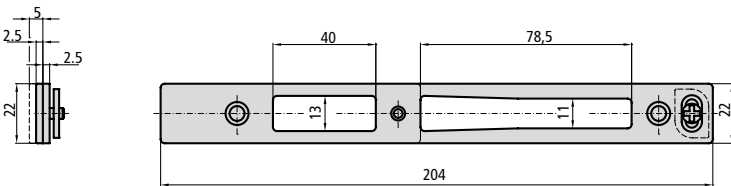

CERRADEROS

DESCRIPCIÓN	REF.	APLICABLE A CERRADURAS	UDS  
 <ul style="list-style-type: none"> <li>Cerradero regulable metálico negro, incluye 1 suplemento de 2,5 mm y otro de 5 mm</li> </ul>	KCE1K5/1NR	1K2, 1K5, central 2K2, central 2K5	-----
 <ul style="list-style-type: none"> <li>Cerradero regulable metálico negro con suplemento, incluye 1 suplemento de 2,5 mm y otro de 5 mm</li> </ul>	KCE1K5/1NRS	1K2, 1K5, central 2K2, central 2K5	-----
 <ul style="list-style-type: none"> <li>Cerradero fijo de acero inoxidable de 22 mm, incluye 1 suplemento de 2,5 mm y otro de 5 mm</li> </ul>	KCE1K5/6L	1K2, 1K5, central 2K2, central 2K5	-----
 <ul style="list-style-type: none"> <li>Cerradero regulable de acero inoxidable, incluye 1 suplemento de 2,5 mm y otro de 5 mm con levas</li> </ul>	KCE1K5/6LR	1K2, 1K5, central 2K2, central 2K5	-----



## PUERTAS BATIENTES

## ACCESORIOS

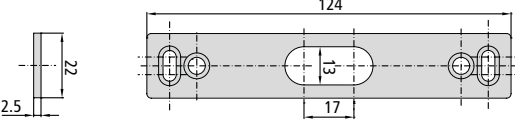
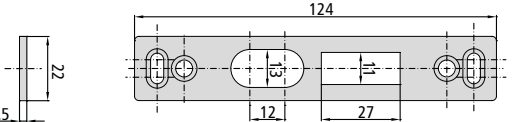
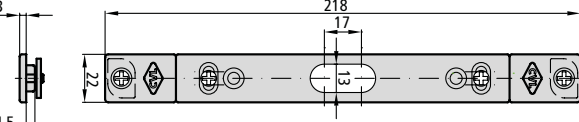
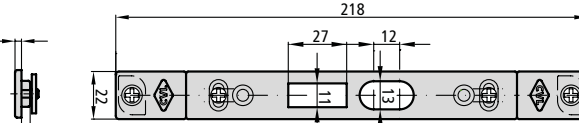
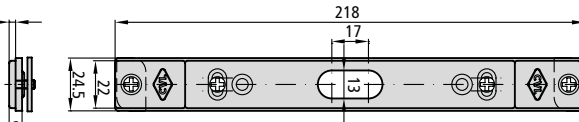
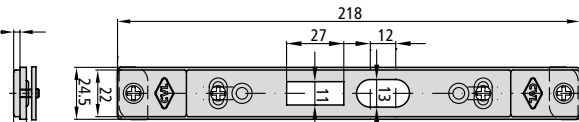
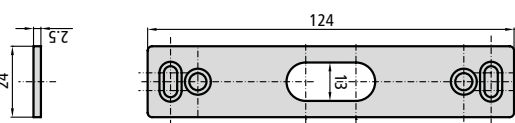
## CERRADEROS

DESCRIPCIÓN	REF.	APLICABLE A CERRADURAS	UDS  
 <ul style="list-style-type: none"> <li>Cerradero fijo de acero inoxidable</li> </ul>	CE202S/6L	alto / bajo 2I2	-----
 <ul style="list-style-type: none"> <li>Cerradero fijo de acero inoxidable</li> </ul>	CE202GB/6L	alto / bajo 2I2GB, 2E2GB	-----
 <ul style="list-style-type: none"> <li>Cerradero regulable metálico negro</li> </ul>	CE202S/1NR	alto / bajo 2I2	-----
 <ul style="list-style-type: none"> <li>Cerradero regulable metálico negro</li> </ul>	CE202GB/1NR	alto / bajo 2I2GB, 2E2GB	-----
 <ul style="list-style-type: none"> <li>Cerradero regulable metálico negro con suplemento</li> </ul>	CE202S/1NRS	alto / bajo 2I2	-----
 <ul style="list-style-type: none"> <li>Cerradero regulable metálico negro con suplemento</li> </ul>	CE202GB/1NRS	alto / bajo 2I2GB, 2E2GB	-----
 <ul style="list-style-type: none"> <li>Cerradero fijo de acero inoxidable de 24 mm</li> </ul>	CE202S/6LAN	alto / bajo 2I2	-----

**PUERTAS BATIENTES**
**ACCESORIOS**
**CERRADEROS**

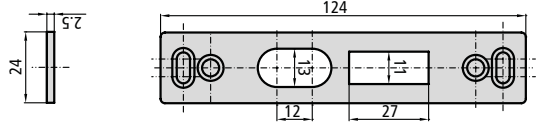
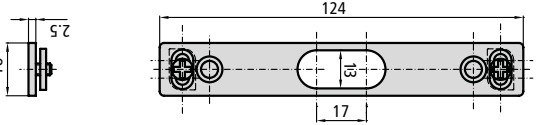
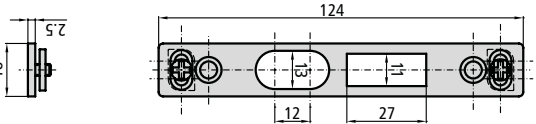
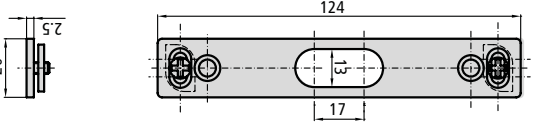
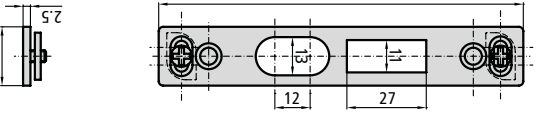
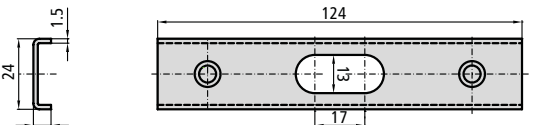

DESCRIPCIÓN	REF.	APLICABLE A CERRADURAS	UDS  
	• Cerradero fijo de acero inoxidable CE202GB/6LAN	alto / bajo 2I2GB, 2E2GB	-----
	• Cerradero regulable de acero inoxidable con levas CE202S/6LR18	alto / bajo 2I2	-----
	• Cerradero regulable de acero inoxidable con levas CE202GB6LR18	alto / bajo 2I2GB, 2E2GB	-----
	• Cerradero regulable de acero inoxidable con levas CE202S/6LR20	alto / bajo 2I2	-----
	• Cerradero regulable de acero inoxidable con levas CE202GB6LR20	alto / bajo 2I2GB, 2E2GB	-----
	• Cerradero regulable de acero inoxidable con levas CE202S/6U	alto / bajo 2I2	-----



## PUERTAS BATIENTES





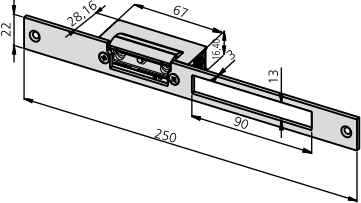
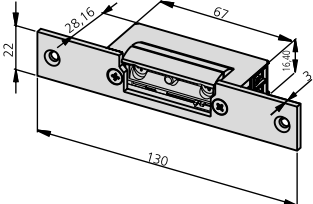



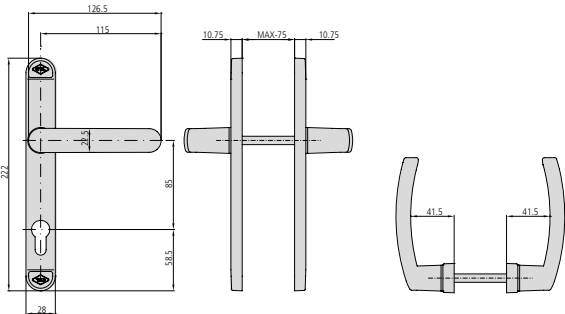

## ACCESORIOS

## CERRADEROS ELÉCTRICOS

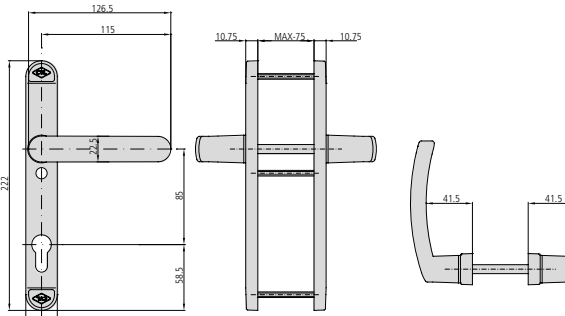
DESCRIPCIÓN	REF.	APLICABLE A CERRADURAS	UDS  
<ul style="list-style-type: none"> <li>Cerradero eléctrico regulable reversible con funcionamiento automático y con desbloqueo</li> <li>Frente plano inox</li> <li>12V/Corriente alterna</li> </ul> 	CEC41/6AD	184, 196, 197, 296, 396, 496, 596, 192, F192, 194, 294N, 494N, 183, 612, 612E, 615E, 615, 2E2GB, 2E2, 2E5, 1E2, 1E5	
<ul style="list-style-type: none"> <li>Cerradero eléctrico regulable reversible con funcionamiento automático y con desbloqueo</li> <li>Sólo picaporte y frente plano inox</li> <li>12V/Corriente alterna</li> </ul> 	CEC41T/6AD	196T, 194T, 183T	

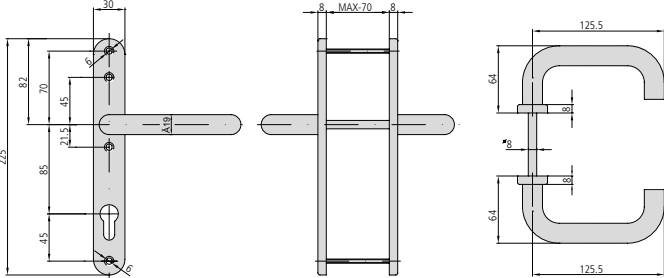
\* Otros tipos de cerradero eléctrico consultar.

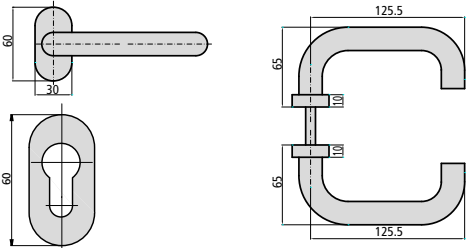
**PUERTAS BATIENTES**
**ACCESORIOS**
**ESCUDOS Y MANILLAS DE ACERO INOXIDABLE**

DESCRIPCIÓN	REF.	ACABADO	CANTO	UDS  
<ul style="list-style-type: none"> <li>Entre centros 85 mm</li> <li>Atado rosca chapa</li> </ul>	JM6006/85/1B JM6006/85/1N	Lacado blanco Lacado negro	Red. Red.	2 2
 				
<ul style="list-style-type: none"> <li>Entre centros 85 mm</li> <li>Atado pasante</li> </ul>	JM6006P/85/1B JM6006P/85/1N	Lacado blanco Lacado negro	Red. Red.	2 2
 				
<ul style="list-style-type: none"> <li>Juego escudo con manilla y bocallave cilindro para aluminio</li> <li>Entre ejes 85 mm</li> <li>No incluye cilindro</li> </ul>	JM6006/85/6R	Al	Red.	2
 				
<ul style="list-style-type: none"> <li>Juego roseta para aluminio más juego escudo</li> </ul>	JMB6000/6R	Al	Red.	2
 				

## PUERTAS BATIENTES

## ACCESORIOS

## ESCUDOS Y MANILLAS DE ACERO INOXIDABLE

DESCRIPCIÓN	REF.	ACABADO	CANTO	UDS  
<ul style="list-style-type: none"> <li>Juego escudo para cilindro</li> </ul> 	JES6000/6R	Al	Red.	2
<ul style="list-style-type: none"> <li>Juego placa con tirador y bocallave de cilindro</li> <li>No incluye cilindro</li> </ul> 	JT6006/85/6R	Al	Red.	2

**PUERTAS BATIENTES**
**ACCESORIOS**
**KIT CONDENA**

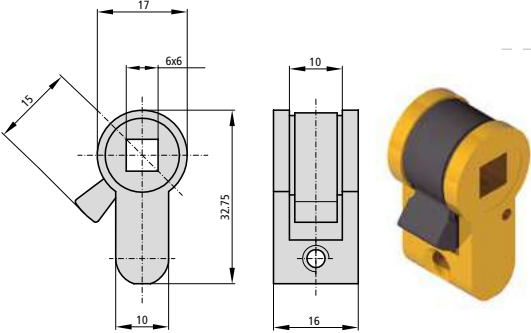
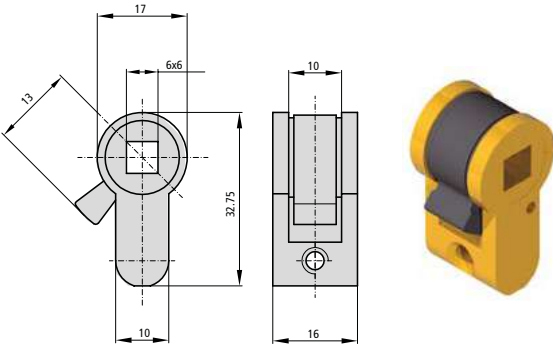
DESCRIPCIÓN	REF.	APLICABLE A CERRADURAS	UDS  
<ul style="list-style-type: none"> <li>Leva larga</li> </ul> 	5982C16	184 (25-30-35) 196 (25-30-35) 192 (25-30-35) 194 (25-30-35)	
<ul style="list-style-type: none"> <li>Leva corta</li> </ul> 	5990C16	184 (21-23-28-33-38) 196 (23-28-33-38)	











## PUERTAS BATIENTES

## ACCESORIOS

## ESCUDOS



DESCRIPCIÓN	REF.	ACABADO	CANTO	UDS
<p>• Escudo de seguridad no pasante, 1 escudo de zamak y 2 tornillos</p> <p>BTI94/1N Negro</p>				
<p>• Escudo de seguridad pasante con contraescudo, 1 escudo de zamak, capucha de nylon para contraescudo y dos tornillos pasantes</p> <p>• 1 escudo de zamak</p> <p>BTI296/1N Negro</p>				
<p>• Escudo de nylon</p> <p>ES1984 Negro</p>				
<p>ES184/1N Lacado negro</p> <p>ES184/1B Lacado blanco</p>				

DESCRIPCIÓN		REF.	APLICABLE A SERIES	UDS  
	• Terminal de nylon	EMB196	184, 192, 196, 197, 194, 1E5, 1E2, 1K5	10
	• Conjunto vaivén	CV1E5	1E5, 2E5, 1E2, 2E2, 294N, 2E2GB, 4E25	1
	• Plástico reductor vaivén	KTVCE15		5
		KTVCE13		5
	• Tapa resbalón para la serie SOFT	TAP1E5	1E5, 2E5, 1E2, 2E2, 2E2GB, 4E25	1
	• Contacto con muelles que se empotran en el marco de la puerta sin dejar cables visibles	CONNECT01	1K5, 1K2, 2K5, 2K2, 2A2	
	• Caja cerradero resbalón estrecho	CACE/RES/E		
	• Caja cerradero palanca estrecho	CACE/PA/E		
	• Caja cerradero alto/bajo estrecho	CACE/AB/E		

## PUERTAS CORREDERAS

## MULTIPUNTO PALANCA GANCHO ENTRE EJES 85 mm.

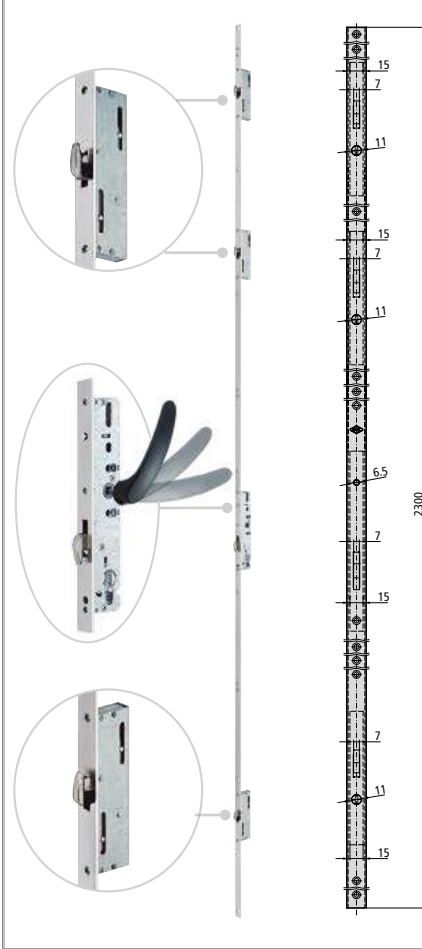
SERIE 4I54K *slide & lock*

## CARACTERÍSTICAS

- Cerraduras para puertas correderas
- Cerradura de 4 puntos con facilidad de cierre mediante manilla hacia arriba (90°) y bloqueo mediante llave
- Cierre mediante 4 ganchos
- **Sistema anti falsa maniobra** (bloqueo de manilla en modo de puerta abierta)
- Posibilidad de atado de manilla a 21,5 mm ↑↓ pasante o directo a la cerradura
- Frente inox U de 2300 x 16 x 6 y 2300 x 22 x 6
- Caja cerrada de 15 mm
- Cuadradillo de 7 mm
- Tornillo de fijación de cilindro

## ACCESORIOS OPCIONALES

- Gama completa de cilindros (ver página 128 - 148)
- Kit acople y punto de cierre adicional (ver página 10)
- Estudio personalizado de cerraderos

## DESCRIPCIÓN

## REF.

MEDIDAS  
B A

## LEVA

ACABADOS  
FRENTE CILINDRO

## UDS

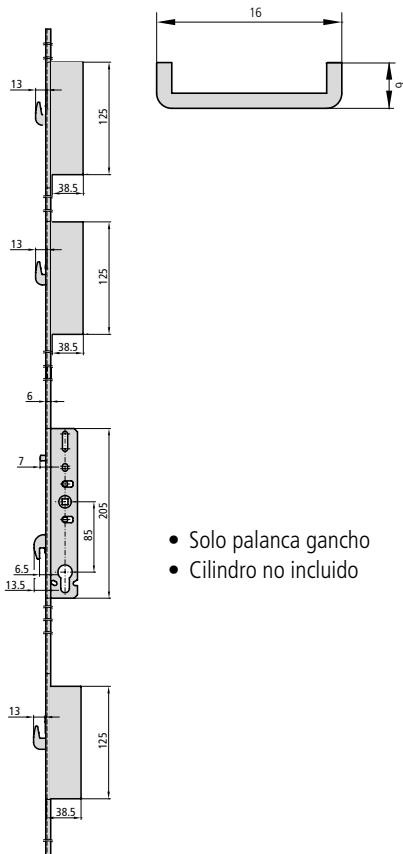

- Solo palanca gancho
- Cilindro no incluido

4I54K256U16	18	33	15	Al	1	
· cuadradillo de 7mm						
4I54K8256U16	18	33	15	Al	1	
· cuadradillo de 8mm						



MULTIPUNTO PALANCA GANCHO ENTRE EJES 85 mm.

SERIE 2I5K *slide & lock*

**CARACTERÍSTICAS**

- Cerraduras para puertas correderas
- Cerradura de 3 puntos con facilidad de cierre mediante manilla hacia arriba (90°) y bloqueo mediante llave
- Cierre mediante 3 ganchos
- **Sistema anti falsa maniobra** (bloqueo de manilla en modo de puerta abierta)
- Posibilidad de atado de manilla a 21,5 mm ↑↓ pasante o directo a la cerradura
- Frente inox U de 1850 x 16 x 6 y 1850 x 22 x 6
- Caja cerrada de 15 mm
- Tornillo de fijación de cilindro

**ACCESORIOS OPCIONALES**

- Gama completa de cilindros (ver página 128 - 148)
- Estudio personalizado de cerraderos

DESCRIPCIÓN	REF.	MEDIDAS		LEVA	ACABADOS		UDS	
		B	A		FRENTE	CILINDRO		

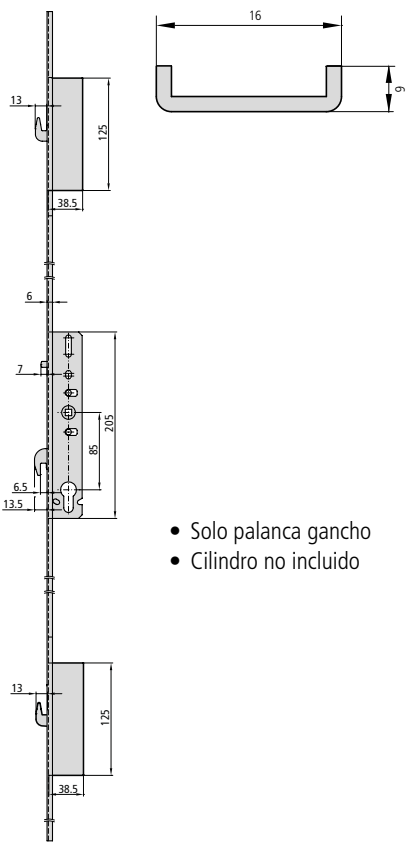

2I5K25/6U16	18	33	15	Al		1		
• cuadradillo de 7mm								
2I5K825/6U16	18	33	15	Al		1		
• cuadradillo de 8mm								

- Solo palanca gancho
- Cilindro no incluido

## PUERTAS CORREDERAS

## PALANCA GANCHO ENTRE EJES 85 mm.

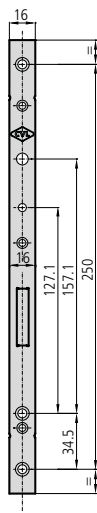
SERIE 1I5K *slide & lock*

## CARACTERÍSTICAS

- Cerraduras para puertas correderas
- Cerradura de 1 punto con facilidad de cierre mediante manilla hacia arriba (90°) y bloqueo mediante llave
- Cierre mediante gancho
- **Sistema anti falsa maniobra** (bloqueo de manilla en modo de puerta abierta)
- Posibilidad de atado de manilla a 21,5 mm ↑↓ pasante o directo a la cerradura
- Frente inox U 16 x 6 mm
- Caja cerrada de 15 mm
- Tornillo de fijación de cilindro

## ACCESSOIRES EN OPTION

- Gama completa de cilindros (ver página 128 - 148)
- Estudio personalizado de cerraderos

## DESCRIPCIÓN

## REF.

MEDIDAS  
B A

## LEVA

ACABADOS  
FRENTE CILINDRO

## UDS



115K25/6U16

18

33

15

Al

1

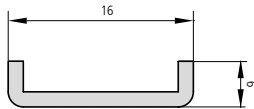
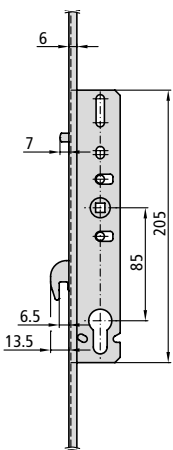

- Cilindro no incluido

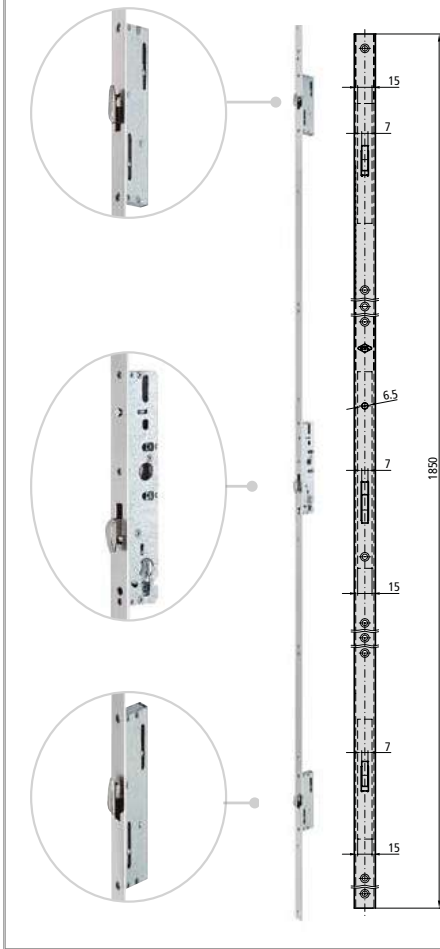
**PUERTAS CORREDERAS**
**MULTIPUNTO PALANCA GANCHO**
**SERIE 297KN *slide & lock***

**CARACTERÍSTICAS**

- Cerraduras para puertas correderas
- Cierre mediante 3 ganchos
- **Sistema anti falsa maniobra**
- Sistema anti elevación mediante palanca gancho
- Frente inox U de 1850 x 16 x 6 mm
- Caja cerrada de 15 mm
- Cuadradillo de 8 mm
- Tornillo de fijación de cilindro

**ACCESORIOS OPCIONALES**

- Gama completa de cilindros (ver página 128 - 148)
- Estudio personalizado de cerraderos

**DESCRIPCIÓN**
**REF.**
**MEDIDAS**  
 B A

**LEVA**
**ACABADOS**  
 FRENTE CILINDRO

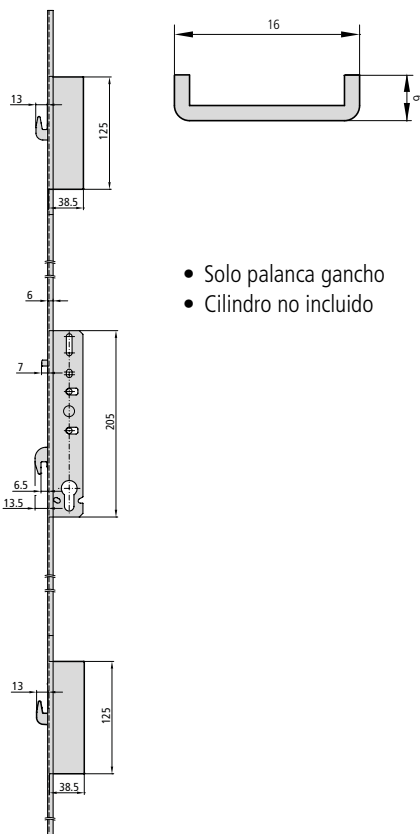
**UDS**

- Solo palanca gancho
- Cilindro no incluido

297KN25/6U16 18 33 15 Al ----- 1

## PUERTAS CORREDERAS

## PALANCA GANCHO Y ANTIFALSA MANIOBRA

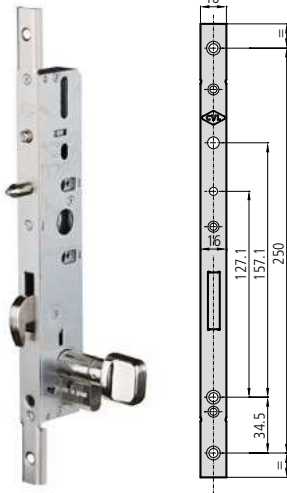
SERIE 197KBN *slide & lock*

## CARACTERÍSTICAS

- Cerraduras para puertas correderas
- Cierre mediante gancho
- **Sistema anti falsa maniobra**
- Bulón de seguridad anti elevación
- Frente inox U de 16 x 6 mm
- Caja cerrada de 15 mm
- Tornillo de fijación de cilindro

## ACCESORIOS OPCIONALES

- Gama completa de cilindros (ver página 128 - 148)
- Estudio personalizado de cerraderos

## DESCRIPCIÓN

## REF.

## MEDIDAS

## LEVA

## ACABADOS

## UDS

B A

FRENTE CILINDRO

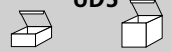

197KBN25/6U16

18

33

15

Al

1

10

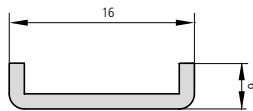
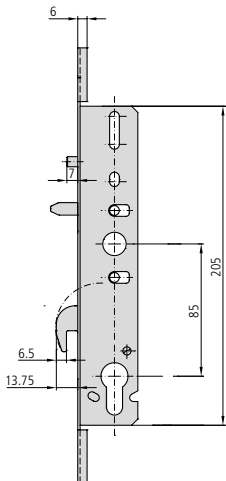

- Cilindro no incluido

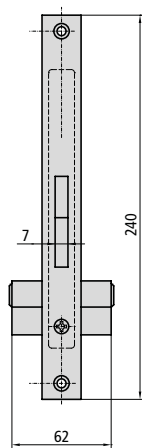
**PUERTAS CORREDERAS**
**PALANCA GANCHO CON CILINDRO EUROPERFIL**
**SERIE 198K *slide & lock***

**CARACTERÍSTICAS**

- Cerraduras para puertas correderas
- Cierre mediante gancho
- Frente inox de 16 mm ó 22 mm
- Caja de 15 mm
- Tornillo de fijación de cilindro
- 2 escudos de nylon ref. ES1984

**ACCESORIOS OPCIONALES**

- Gama completa de cilindros (ver página 128 - 148)
- Estudio personalizado de cerraderos

DESCRIPCIÓN	REF.	MEDIDAS		LEVA	ACABADOS		UDS		
		B	A		FRENTE	CILINDRO			
<ul style="list-style-type: none"> <li>• Cilindro de leva larga 5982/2525/4</li> </ul>									
	P198K25/6	22	37	15	AI	CN	1	20	
	P198K30/6	27	42	15	AI	CN	1	20	
	P198K35/6	32	47	15	AI	CN	1	20	
	198K25/6	22	37	15	AI	CN	1	20	
198K30/6	27	42	15	AI	CN	1	20		
198K35/6	32	47	15	AI	CN	1	20		
<ul style="list-style-type: none"> <li>• Bulón de seguridad</li> <li>• Cilindro de leva larga 5982/2525/4</li> </ul>									
	P198KB25/6	22	37	15	AI	CN	1	20	
	P198KB30/6	27	42	15	AI	CN	1	20	
	P198KB35/6	32	47	15	AI	CN	1	20	
	198KB25/6	22	37	15	AI	CN	1	20	
198KB30/6	27	42	15	AI	CN	1	20		
198KB35/6	32	47	15	AI	CN	1	20		
<ul style="list-style-type: none"> <li>• Bulón de seguridad deslizante</li> <li>• Cilindro de leva corta 5990/2525/4</li> </ul>									
	P198KD20/6	17	30	13,25	AI	CN	1	20	
	198KD20/6	17	30	13,25	AI	CN	1	20	

# PUERTAS CORREDERAS

## PALANCA GANCHO CON CILINDRO TETRA

## SERIE 1T8 *slide & lock*

### CARACTERÍSTICAS

- Cerraduras para puertas correderas
- Cierre mediante gancho
- Bulón de seguridad anti elevación
- Frente inox de 16 mm, 17 mm ó 22 mm
- Caja de 15 mm
- 2 escudos de nylon blanco o negro a escoger

### ACCESORIOS OPCIONALES

- Estudio personalizado de cerraderos

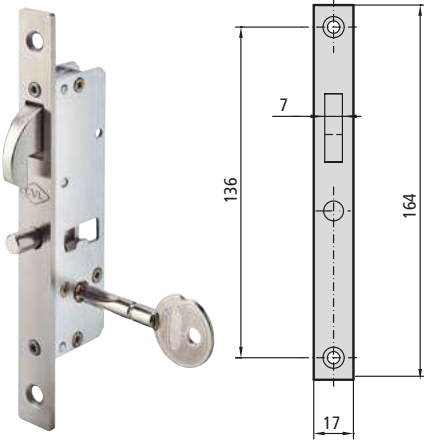

### DESCRIPCIÓN

### REF.

### MEDIDAS B A

### LEVA

### ACABADOS FRETE ESCUDOS

### UDS

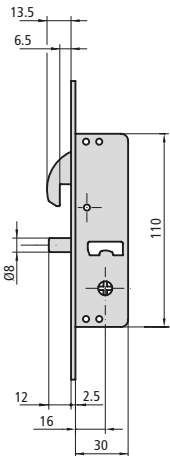

- Cilindro tetra con llave en cruz

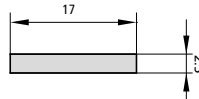

1T8KD20/6L17B

16

30

Al

Blanco

1

20

1T8KD20/6L17N

16

30

Al

Negro

1

20

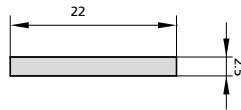

1T8KD20/6LB

16

30

Al

Blanco

1

20

1T8KD20/6LN

16

30

Al

Negro

1

20

## CERRADURAS DE EMBUTIR PARA CARPINTERÍA METÁLICA



Palanca deslizante entre ejes 85 cilindro europerfil leva corta	64
• Serie 1984	64
Palanca deslizante entre ejes 85 cilindro europerfil leva larga	65
• Serie 1995	65
Palanca gancho entre ejes 85 cilindro europerfil	67
• Serie 190	67
• Serie 1990	68
• Serie 1994	69
Multipunto palanca gancho entre ejes 85	71
• Serie 2994	71
• Serie 3994	73
Palanca deslizante entre ejes 92 cilindro europerfil	75
• Serie 1992	75
Palanca deslizante entre ejes 70 cilindro europerfil	76
• Serie 1983	76
Palanca deslizante entre ejes 85 cilindro ovalado monoblock	78
• Serie 1963	78
• Serie 1975	80
Palanca deslizante entre ejes 74 cilindro ovalado de vástagos	81
• Serie 1964	81
Cerradura para puertas de zócalo con cilindro ovalado de vástagos	83
• Serie 1981	83
Cerradura para puertas de zócalo con cilindro europerfil	84
• Serie 1991	84
Cerradura de sólo gancho con cilindro ovalado de vástagos	85
• Serie 1968	85
Cerradura de sólo gancho con cilindro europerfil	86
• Serie 1982	86
Cerradura de sólo picaporte para puertas metálicas	87
• Serie 1979	87
Cerradura para puertas y persianas metálicas enrollables	88
• Serie 11A	88
Cerradura para puertas metálicas basculantes	89
• Serie 11B	89
Accesorios	90
• Cerraderos para cerraduras metálicas	90
• Cerraderos eléctricos	93
• Escudos	94
• Escudos de seguridad	94
• Kit condena	94



**PALANCA DESLIZANTE ENTRE EJES 85 CILINDRO EUROPERFIL LEVA CORTA**

**SERIE 1984**

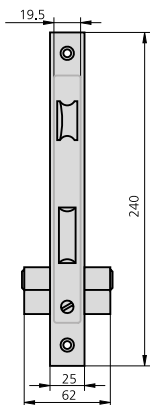

**CARACTERÍSTICAS**

- Frente hierro niquelado ó acero inoxidable
- Caja bicromatada
- Palanca deslizante
- Picaporte reversible
- Cuadradillo de 8 mm
- Cilindro europerfil
- 2 escudos de nylon ref. ES1984
- Tornillo de fijación de cilindro

**ACCESORIOS OPCIONALES**

- Cerraderos según cerradura (ver abajo)
- Gama completa de cilindros (ver página 128 - 148)

DESCRIPCIÓN	REF.	MEDIDAS		LEVA	ACABADOS		UDS	
		B	A		FRENTE	CILINDRO		

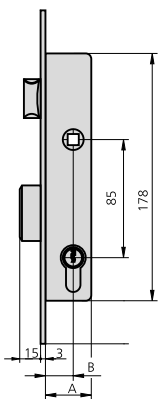

- Picaporte y palanca
- Cilindro 5990/2525

**Opciones de cerradero**

- CE1984/0 o CE1984/6

**Opción cerraderos eléctricos**

- CEC45/6A
- CEC45/6AD

1984/20/0	20	33	13,25	HN	CN	1	20
1984/20/5	20	33	13,25	HN	CL	1	20
1984/20/6	20	33	13,25	AI	CN	1	20
1984/25/0	25	38	13,25	HN	CN	1	20
1984/25/5	25	38	13,25	HN	CL	1	20
1984/25/6	25	38	13,25	AI	CN	1	20
1984/30/0	30	43	13,25	HN	CN	1	20
1984/30/5	30	43	13,25	HN	CL	1	20
1984/30/6	30	43	13,25	AI	CN	1	20

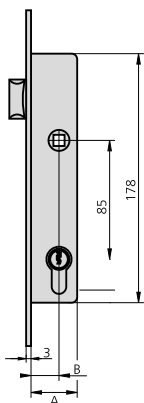

- Sólo picaporte
- Cilindro 5982T40/4

**Opción cerraderos eléctricos**

- CEC45/6A o CEC45/6AD

1984T20/6	20	33	15	AI	CN	1	20
1984T25/6	25	38	15	AI	CN	1	20
1984T30/6	30	43	15	AI	CN	1	20

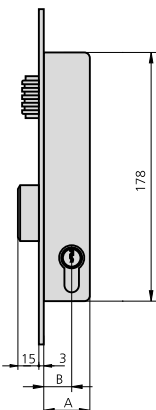

- Rodillo vaivén regulable y palanca
- Cilindro 5990/2525

**Opciones de cerradero**

- CE1984/6

1984V20/6	20	33	13,25	AI	CN	1	20
1984V25/6	25	38	13,25	AI	CN	1	20
1984V30/6	30	43	13,25	AI	CN	1	20

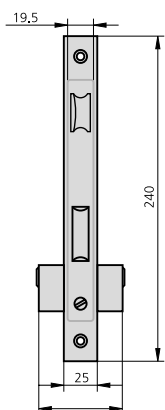

**CARACTERÍSTICAS**

- Frente hierro niquelado ó acero inoxidable
- Caja bicromatada
- Palanca deslizante
- Picaporte reversible
- Cuadradillo de 8 mm
- Cilindro europerfil
- 2 escudos de nylon ref. ES1984
- Tornillo de fijación de cilindro

**ACCESORIOS OPCIONALES**

- Cerraderos según cerradura (ver abajo)
- Amplia gama de cilindros (ver página 128 - 148)

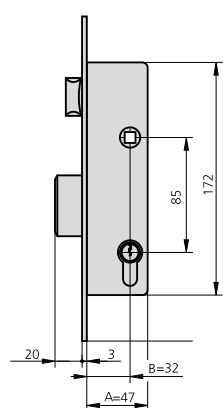
DESCRIPCIÓN	REF.	MEDIDAS		LEVA	ACABADOS		UDS	
		B	A		FRENTE	CILINDRO		



- Picaporte y palanca
- Cilindro 5982/2525

1995/32/0	32	47	15	HN	CN	1	20
1995/32/5	32	47	15	HN	CL	1	20
1995/32/6	32	47	15	Al	CN	1	20

**Opciones de cerradero**

- CE1984/0 o CE1984/6

**Opciones cerraderos eléctricos**

- CELC45/6A o CELC45/6AD

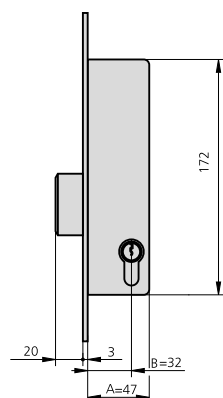

- Sólo palanca
- Cilindro 5982/2525/4

1995A32/6	32	47	15	Al	CN	1	20
-----------	----	----	----	----	----	---	----

**Opciones de cerradero**

- CE2994S/6

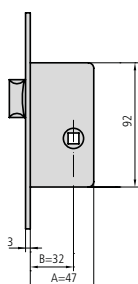



- Sólo picaporte
- Sin cilindro

1995R32/0	32	47		HN		1	30
-----------	----	----	--	----	--	---	----

**PALANCA DESLIZANTE ENTRE EJES 85 CILINDRO EUROPERFIL LEVA LARGA**

**SERIE 1995**

DESCRIPCIÓN	REF.	MEDIDAS		LEVA	ACABADOS		UDS	
		B	A		FRENTE	CILINDRO		

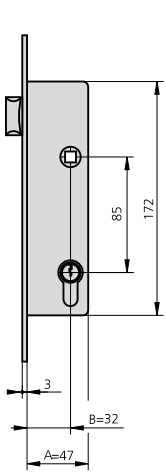

- Sólo picaporte
- Cilindro 5982T40/4

1995T32/6	32	47	15	Al	CN	1	20
-----------	----	----	----	----	----	---	----

**Opciones cerraderos eléctricos**

- CELC45T/6A o CELC45T/6AD

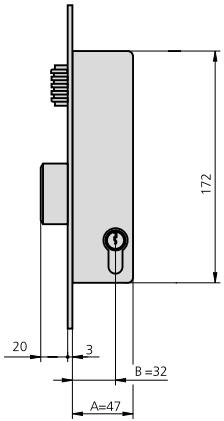

- Rodillo vaivén regulable y palanca
- Cilindro 5982/2525/4

1995V32/6	32	47	15	Al	CN	1	20
-----------	----	----	----	----	----	---	----

**Opciones de cerradero**

- CE1984/6



**CARACTERÍSTICAS**

- Frente de 24 mm
- Picaporte reversible
- Caja bicromatada de 15 mm
- Cuadradillo de 8 mm
- Cilindro europerfil
- 2 escudos de nylon ref. ES1984
- Tornillo de fijación de cilindro

**ACCESORIOS OPCIONALES**

- Gama completa de cilindros (ver página 128 - 148)

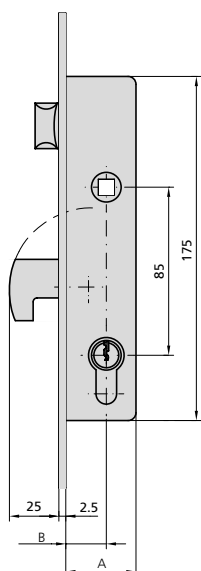
DESCRIPCIÓN	REF.	MEDIDAS		LEVA	ACABADOS		UDS	
		B	A		FRENTE	CILINDRO		



- Picaporte y palanca
- Cilindro 5990/2525

**Opciones de cerradero**

- CE190/0 o CE190/6

**Opciones cerraderos eléctricos**

- CELC45/6A o CELC45/6AD

190/23/0	20	33	13,25	HN	CN	1	20
190/23/5	20	33	13,25	HN	CL	1	20
190/23/6	20	33	13,25	AI	CN	1	20
190/28/0	25	38	13,25	HN	CN	1	20
190/28/5	25	38	13,25	HN	CL	1	20
190/28/6	25	38	13,25	AI	CN	1	20
190/33/0	30	43	13,25	HN	CN	1	20
190/33/5	30	43	13,25	HN	CL	1	20
190/33/6	30	43	13,25	AI	CN	1	20

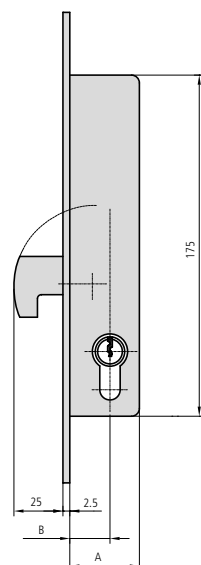

- Solo palanca
- Cilindro 5990/2525

**Opciones de cerradero**

- CE190/0 o CE190/6

190A23/0	20	33	13,25	HN	CN	1	20
190A23/5	20	33	13,25	HN	CL	1	20
190A23/6	20	33	13,25	AI	CN	1	20
190A28/0	25	38	13,25	HN	CN	1	20
190A28/5	25	38	13,25	HN	CL	1	20
190A28/6	25	38	13,25	AI	CN	1	20
190A33/0	30	43	13,25	HN	CN	1	20
190A33/5	30	43	13,25	HN	CL	1	20
190A33/6	30	43	13,25	AI	CN	1	20

**PALANCA GANCHO ENTRE EJES 85 CILINDRO EUROPERFIL**

**SERIE 1990**

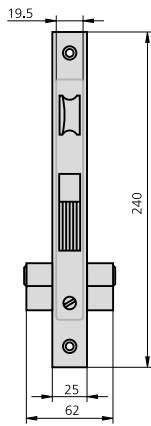

**CARACTERÍSTICAS**

- Frente hierro niquelado o acero inoxidable
- Caja bicromatada
- Palanca basculante de gancho
- Picaporte reversible
- Cuadradillo de 8 mm
- Cilindro europerfil
- 2 escudos de nylon ref. ES1984
- Tornillo de fijación de cilindro

**ACCESORIOS OPCIONALES**

- Gama completa de cilindros (ver página 128 - 148)

DESCRIPCIÓN	REF.	MEDIDAS		LEVA	ACABADOS		UDS	
		B	A		FRENTE	CILINDRO		

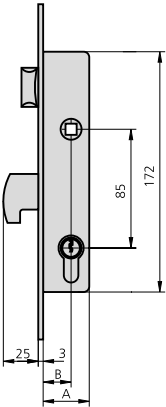

- Picaporte y palanca
- Cilindro 5990/2525 o 5982/2525
- Cerradero CE1990/0
- Opciones cerraderos eléctricos**
- CELC45/6A o CELC45/6AD

1990/20/0	20	33	13,25	HN	CN	1	20
1990/20/5	20	33	13,25	HN	CL	1	20
1990/20/6	20	33	13,25	AI	CN	1	20
1990/25/0	25	38	13,25	HN	CN	1	20
1990/25/5	25	38	13,25	HN	CL	1	20
1990/25/6	25	38	13,25	AI	CN	1	20
1990/32/0	32	47	15	HN	CN	1	20
1990/32/5	32	47	15	HN	CL	1	20
1990/32/6	32	47	15	AI	CN	1	20

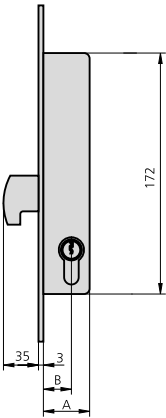

- Sólo palanca
- Cilindro 5990/2525 o 5982/2525
- Cerradero CE1990/0

1990A20/0	20	33	13,25	HN	CN	1	20
1990A20/5	20	33	13,25	HN	CL	1	20
1990A20/6	20	33	13,25	AI	CN	1	20
1990A25/0	25	38	13,25	HN	CN	1	20
1990A25/5	25	38	13,25	HN	CL	1	20
1990A25/6	25	38	13,25	AI	CN	1	20
1990A32/0	32	47	15	HN	CN	1	20
1990A32/5	32	47	15	HN	CL	1	20
1990A32/6	32	47	15	AI	CN	1	20

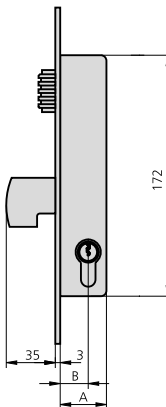

- Rodillo vaivén regulable y palanca
- Cilindro 5990/2525 o 5982/2525
- Cerradero CE1990/0

1990V20/0	20	33	13,25	HN	CN	1	20
1990V20/5	20	33	13,25	HN	CL	1	20
1990V20/6	20	33	13,25	AI	CN	1	20
1990V25/0	25	38	13,25	HN	CN	1	20
1990V25/5	25	38	13,25	HN	CL	1	20
1990V25/6	25	38	13,25	AI	CN	1	20
1990V32/0	32	47	15	HN	CN	1	20
1990V32/5	32	47	15	HN	CL	1	20
1990V32/6	32	47	15	AI	CN	1	20

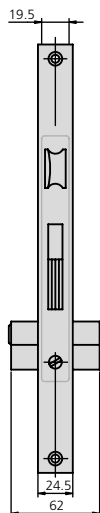
**CARACTERÍSTICAS**

- Frente de acero inoxidable
- Caja bicromatada
- Palanca basculante de gancho
- Picaporte reversible
- Cuadradillo de 8 mm
- Cilindro europerfil
- Tornillo de fijación de cilindro
- Cerradero según cerradura

**ACCESORIOS OPCIONALES**

- Gama completa de cilindros (ver página 128 - 148)

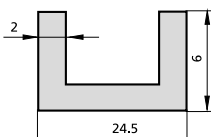
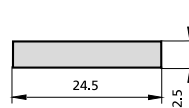
**FRENTE U**

**FRENTE LISO**
**DESCRIPCIÓN**
**REF.**
**MEDIDAS**
**LEVA**
**ACABADOS**
**UDS**
**B A**
**FRENTE CILINDRO**

- Picaporte y palanca
- Cilindro 5982/2525/4
- Cerradero CE1994/6

**FRENTE U**
**Opciones cerraderos eléctricos**

- CELC45/6A o CELC45/6AD

1994/25/6U

18

33

15

AI

CN

1

10

1994/30/6U

23

38

15

AI

CN

1

10

1994/35/6U

28

43

15

AI

CN

1

10

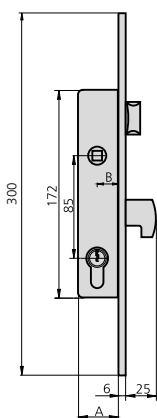

- Picaporte y palanca
- Cilindro 5982/2525/4
- Cerradero CE1994/6

**FRENTE LISO**
**Opciones cerraderos eléctricos**

- CELC45/6A o CELC45/6AD

1994/25/6L

22

37

15

AI

CN

1

20

1994/30/6L

27

42

15

AI

CN

1

20

1994/35/6L

32

47

15



AI

CN

1

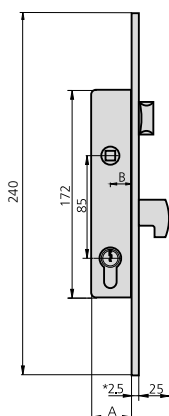
20

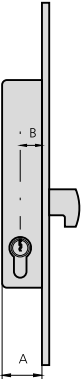

DESCRIPCIÓN	REF.	MEDIDAS		LEVA	ACABADOS		UDS	
		B	A		FRENTE	CILINDRO		
 <ul style="list-style-type: none"> <li>• Sólo palanca</li> <li>• Cilindro 5982/2525/4</li> <li>• Cerradero CE1994/6</li> </ul>	1994A25/6U	18	33	15	Al	CN	1	10
	1994A30/6U	23	38	15	Al	CN	1	10
	1994A35/6U	28	43	15	Al	CN	1	10
<ul style="list-style-type: none"> <li>• Sólo palanca</li> <li>• Cilindro 5982/2525/4</li> <li>• Cerradero CE1994/6</li> </ul>	1994A25/6L	22	37	15	Al	CN	1	20
	1994A30/6L	27	42	15	Al	CN	1	20
	1994A35/6L	32	47	15	Al	CN	1	20

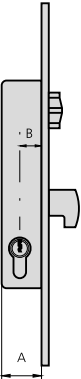
 <ul style="list-style-type: none"> <li>• Rodillo vaivén regulable y palanca</li> <li>• Cilindro 5982/2525/4</li> <li>• Cerradero CE1994/6</li> </ul>	1994V25/6U	18	33	15	Al	CN	1	10
	1994V30/6U	23	38	15	Al	CN	1	10
	1994V35/6U	28	43	15	Al	CN	1	10
<ul style="list-style-type: none"> <li>• Rodillo vaivén regulable y palanca</li> <li>• Cilindro 5982/2525/4</li> <li>• Cerradero CE1994/6</li> </ul>	1994V25/6L	22	37	15	Al	CN	1	20
	1994V30/6L	27	42	15	Al	CN	1	20
	1994V35/6L	32	47	15	Al	CN	1	20

### CARACTERÍSTICAS

- Frente de acero inoxidable
- Caja bicromatada
- Palanca basculante de gancho
- Picaporte reversible
- Cuadradillo de 8 mm

- Cilindro euoperfil de seguridad
- Tornillo de fijación de cilindro
- Cerradero según cerradura
- Escudo de seguridad BTI94/1N

### ACCESORIOS OPCIONALES

- Gama completa de cilindros (ver página 128 - 148)

**FRENTE U**

**FRENTE LISO**

DESCRIPCIÓN	REF.	MEDIDAS		LEVA	ACABADOS		UDS	
		B	A		FRENTE	CILINDRO		

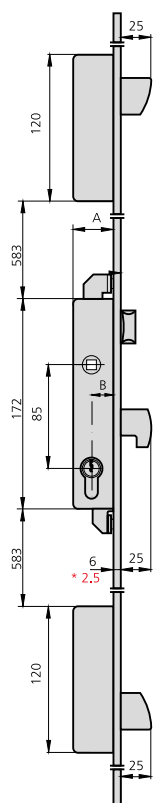

- FRENTE U**
- Picaporte y palanca
  - Cilindro 6982/2525/4
  - Cerradero CE1994/6
  - Cerradero alto/bajo CE2994S/6
  - Escudo de seguridad BTI94/1N



2994/25/6U	18	33	15	AI	CN	1	
2994/30/6U	23	38	15	AI	CN	1	
2994/35/6U	28	43	15	AI	CN	1	

- FRENTE LISO**
- Picaporte y palanca
  - Cilindro 6982/2525/4
  - Cerradero CE1994/6
  - Cerradero alto/bajo CE2994S/6
  - Escudo de seguridad BTI94/1N

2994/25/6L	22	37	15	AI	CN	1	
2994/30/6L	27	42	15	AI	CN	1	
2994/35/6L	32	47	15	AI	CN	1	

\* Medidas en frente liso

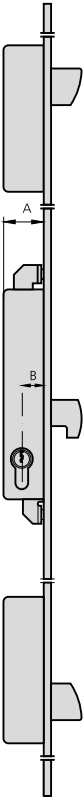
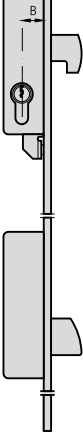

DESCRIPCIÓN	REF.	MEDIDAS		LEVA	ACABADOS		UDS	
		B	A		FRENTE	CILINDRO		
 <p><b>FRENTE U</b></p> <ul style="list-style-type: none"> <li>Sólo palanca</li> <li>Cilindro 6982/2525/4</li> <li>Cerradero CE1994/6</li> <li>Cerradero alto/bajo CE2994S/6</li> <li>Escudo de seguridad BT194/1N</li> </ul>	2994A25/6U	18	33	15	Al	CN	1	
	2994A30/6U	23	38	15	Al	CN	1	
	2994A35/6U	28	43	15	Al	CN	1	
 <p><b>FRENTE LISO</b></p> <ul style="list-style-type: none"> <li>Sólo palanca</li> <li>Cilindro 6982/2525/4</li> <li>Cerradero CE1994/6</li> <li>Cerradero alto/bajo CE2994S/6</li> <li>Escudo de seguridad BT194/1N</li> </ul>	2994A25/6L	22	37	15	Al	CN	1	
	2994A30/6L	27	42	15	Al	CN	1	
	2994A35/6L	32	47	15	Al	CN	1	

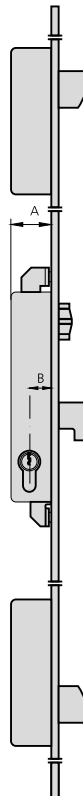
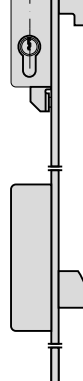
 <p><b>FRENTE U</b></p> <ul style="list-style-type: none"> <li>Rodillo vaivén regulable y palanca</li> <li>Cilindro 6982/2525/4</li> <li>Cerraderos CE1994/6</li> <li>Cerraderos alto/bajo CE2994S/6</li> <li>Escudo de seguridad BT194/1N</li> </ul>	2994V25/6U	18	33	15	Al	CN	1	
	2994V30/6U	23	38	15	Al	CN	1	
	2994V35/6U	28	43	15	Al	CN	1	
 <p><b>FRENTE LISO</b></p> <ul style="list-style-type: none"> <li>Rodillo vaivén regulable y palanca</li> <li>Cilindro 6982/2525/4</li> <li>Cerraderos CE1994/6</li> <li>Cerraderos alto/bajo CE2994S/6</li> <li>Escudo de seguridad BT194/1N</li> </ul>	2994V25/6L	22	37	15	Al	CN	1	
	2994V30/6L	27	42	15	Al	CN	1	
	2994V35/6L	32	47	15	Al	CN	1	

**CARACTERÍSTICAS**

- Cerradura de 3 puntos mediante barra roscada de M8
- Frente de acero inoxidable
- Caja bicromatada
- Palanca basculante de gancho
- Picaporte reversible
- Cuadradillo de 8 mm

- Cilindro de seguridad
- Tornillo de fijación de cilindro
- Cerradero según cerradura
- Escudo de seguridad ref. BT194/1N

**ACCESORIOS OPCIONALES**

- Gama completa de cilindros (ver página 128 - 148)

**FRENTE U**

**FRENTE LISO**

DESCRIPCIÓN	REF.	MEDIDAS		LEVA	ACABADOS		UDS	
		B	A		FRENTE	CILINDRO		

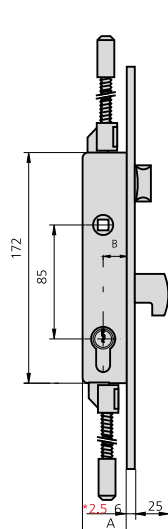

<b>FRENTE U</b>	• Picaporte y palanca	3994/25/6U	18	33	15	AI	CN	1	10
	• Cilindro 6982/2525/4	3994/30/6U	23	38	15	AI	CN	1	10
	• Cerradero CE1994/6	3994/35/6U	28	43	15	AI	CN	1	10
	• Escudo de seguridad BT194/1N								
<b>FRENTE LISO</b>	• Picaporte y palanca	3994/25/6L	22	37	15	AI	CN	1	10
	• Cilindro 6982/2525/4	3994/30/6L	27	42	15	AI	CN	1	10
	• Cerradero CE1994/6	3994/35/6L	32	47	15	AI	CN	1	10
	• Escudo de seguridad BT194/1N								

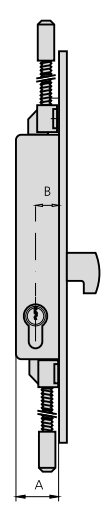

<b>FRENTE U</b>	• Sólo palanca	3994A25/6U	18	33	15	AI	CN	1	10
	• Cilindro 6982/2525/4	3994A30/6U	23	38	15	AI	CN	1	10
	• Cerradero CE1994/6	3994A35/6U	28	43	15	AI	CN	1	10
	• Escudo de seguridad BT194/1N								
<b>FRENTE LISO</b>	• Sólo palanca	3994A25/6L	22	37	15	AI	CN	1	10
	• Cilindro 6982/2525/4	3994A30/6L	27	42	15	AI	CN	1	10
	• Cerradero CE1994/6	3994A35/6L	32	47	15	AI	CN	1	10
	• Escudo de seguridad BT194/1N								

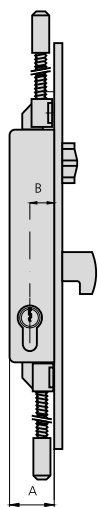

DESCRIPCIÓN	REF.	MEDIDAS		LEVA	ACABADOS		UDS	
		B	A		FRENTE	CILINDRO		
<ul style="list-style-type: none"> <li>Rodillo vaivén regulable y palanca</li> <li>Cilindro 6982/2525/4</li> <li>Cerradero CE1994/6</li> <li>Escudo de seguridad BT194/1N</li> </ul>	3994V25/6U	18	33	15	Al	CN	1	10
	3994V30/6U	23	38	15	Al	CN	1	10
	3994V35/6U	28	43	15	Al	CN	1	10

<ul style="list-style-type: none"> <li>Rodillo vaivén regulable y palanca</li> <li>Cilindro 6982/2525/4</li> <li>Cerradero CE1994/6</li> <li>Escudo de seguridad BT194/1N</li> </ul>	3994V25/6L	22	37	15	Al	CN	1	10
	3994V30/6L	27	42	15	Al	CN	1	10
	3994V35/6L	32	47	15	Al	CN	1	10

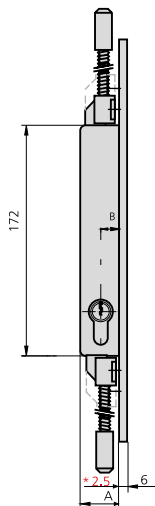

<ul style="list-style-type: none"> <li>Sin palanca y sin picaporte</li> <li>Cilindro 6982/2525/4</li> <li>Escudo de seguridad BT194/1N</li> </ul>	3994F25/6U	18	33	15	Al	CN	1	10
	3994F30/6U	23	38	15	Al	CN	1	10
	3994F35/6U	28	43	15	Al	CN	1	10

<ul style="list-style-type: none"> <li>Sin palanca y sin picaporte</li> <li>Cilindro 6982/2525/4</li> <li>Escudo de seguridad BT194/1N</li> </ul>	3994F25/6L	22	37	15	Al	CN	1	10
	3994F30/6L	27	42	15	Al	CN	1	10
	3994F35/6L	32	47	15	Al	CN	1	10

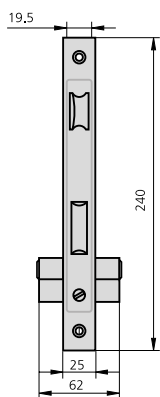

**CARACTERÍSTICAS**

- Frente de acero inoxidable
- Caja bicromatada
- Palanca deslizante
- Picaporte reversible
- Cuadradillo de 8 mm
- Cilindro europerfil
- 2 escudos de nylon ref. ES1984
- Tornillo de fijación de cilindro

**ACCESORIOS OPCIONALES**

- Cerraderos según cerradura (ver abajo)
- Gama completa de cilindros (ver página 128 - 148)

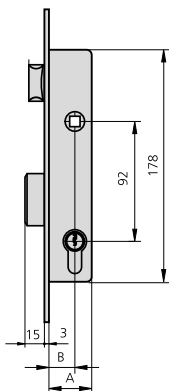
DESCRIPCIÓN	REF.	MEDIDAS		LEVA	ACABADOS		UDS	
		B	A		FRENTE	CILINDRO		



- Picaporte y palanca
- Cilindro 5990/2525

1992/20/6	20	33	13,25	Al	CN	1	20
1992/25/6	25	38	13,25	Al	CN	1	20
1992/30/6	30	43	13,25	Al	CN	1	20

**Opciones de cerradero**

- CE1984/6

**Opciones cerraderos eléctricos**

- CELC45/6A o CELC45 /6AD

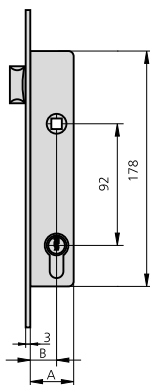

- Sólo picaporte
- Cilindro 5982T40/4

1992T20/6	20	33	15	Al	CN	1	20
1992T25/6	25	38	15	Al	CN	1	20
1992T30/6	30	43	15	Al	CN	1	20

**Opciones cerraderos eléctricos**

- CELC45T/6A o CELC45T/6AD

**PALANCA DESLIZANTE ENTRE EJES 70 CILINDRO EUROPERFIL**

**SERIE 1983**

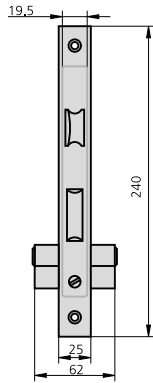

**CARACTERÍSTICAS**

- Frente hierro niquelado o acero inoxidable
- Caja bicromatada
- Palanca deslizante
- Picaporte reversible
- Cuadradillo de 8 mm
- Cilindro europerfil
- 2 escudos de nylon ref. ES1984
- Tornillo de fijación de cilindro

**ACCESORIOS OPCIONALES**

- Cerraderos según cerradura (ver abajo)
- Gama completa de cilindros (ver página 128 - 148)

DESCRIPCIÓN	REF.	MEDIDAS		LEVA	ACABADOS		UDS	
		B	A		FRENTE	CILINDRO		

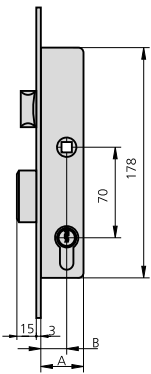

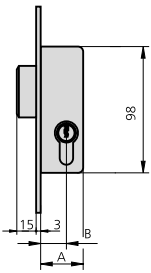

• Picaporte y palanca	1983/20/0	20	33	13,25	HN	CN	1	20
• Cilindro 5990/2525	1983/20/5	20	33	13,25	HN	CL	1	20
	1983/20/6	20	33	13,25	Al	CN	1	20
<b>Opciones de cerradero</b>	1983/25/0	25	38	13,25	HN	CN	1	20
• CE1983/6	1983/25/5	25	38	13,25	HN	CL	1	20
<b>Opciones cerraderos eléctricos</b>	1983/25/6	25	38	13,25	Al	CN	1	20
• CELC45/6A o CELC45/6AD	1983/30/0	30	43	13,25	HN	CN	1	20
	1983/30/5	30	43	13,25	HN	CL	1	20
	1983/30/6	30	43	13,25	Al	CN	1	20

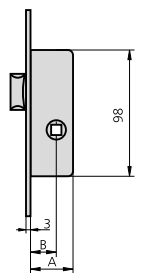

• Sólo palanca	1983A20/0	20	33	13,25	HN	CN	1	30
• Cilindro 5990/2525	1983A20/5	20	33	13,25	HN	CL	1	30
	1983A25/0	25	38	13,25	HN	CN	1	30
<b>Opciones de cerradero</b>	1983A25/5	25	38	13,25	HN	CL	1	30
• CE2994S/6	1983A30/0	30	43	13,25	HN	CN	1	30
	1983A30/5	30	43	13,25	HN	CL	1	30



• Cerradura de sólo picaporte	1983R20/0	20	33		HN		2	60
	1983R25/0	25	38		HN		2	60
• Sin cilindro	1983R30/0	30	43		HN		1	30
<b>Opciones de cerradero</b>								
• CE1991/0								

DESCRIPCIÓN	REF.	MEDIDAS		LEVA	ACABADOS		UDS	
		B	A		FRENTE	CILINDRO		

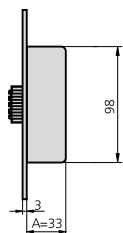

- Cerradura de sólo vaivén
- Sin cilindro

1983RV/0	33	HN	2	60
----------	----	----	---	----

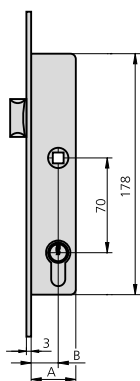

- Sólo picaporte
- Cilindro 5982T40/4

1983T20/6	20	33	15	Al	CN	1	20
1983T25/6	25	38	15	Al	CN	1	20
1983T30/6	30	43	15	Al	CN	1	20

**Opciones de cerraderos eléctricos**

- CELC45T/6A o CELC45T/6AD

**PALANCA DESLIZANTE ENTRE EJES 85 CILINDRO OVALADO MONOBLOCK**

**SERIE 1963**

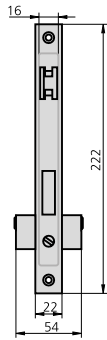

**CARACTERÍSTICAS**

- Frente de hierro niquelado o acero inoxidable
- Caja bicromatada
- Palanca deslizante
- Picaporte reversible
- Cuadradillo de 8 mm
- Cilindro ovalado monoblock (5963)
- 2 escudos de nylon ref. ES1963
- Tornillo de fijación de cilindro

**ACCESORIOS OPCIONALES**

- Cerraderos según cerradura (ver abajo)
- Cilindros (ver página 144)

DESCRIPCIÓN	REF.	MEDIDAS		LEVA	ACABADOS		UDS	
		B	A		FRENTE	CILINDRO		

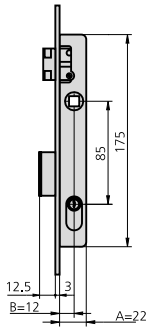

- Picaporte y palanca
- Cilindro 5963/2222

1963/0	12	22	HN	CN	1	20
1963/5	12	22	HN	CL	1	20
1963/6	12	22	AI	CN	1	20

- Opciones de cerradero**
- CE1984/0 o CE1984/6

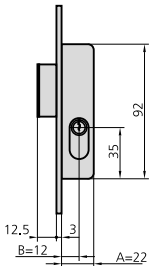

- Cerradura de sólo palanca
- Cilindro 5963/2222

1963A/0	12	22	HN	CN	1	30
1963A/5	12	22	HN	CL	1	30
1963A/6	12	22	AI	CN	1	30

- Opciones de cerradero**
- CE2994S/6

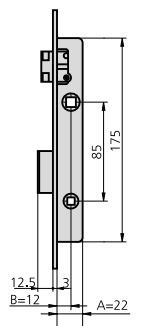

- Cerradura de condena
- Sin cilindro

1963C/6	12	22	AI		2	40
---------	----	----	----	--	---	----

- Opciones de cerradero**
- CE1984/6

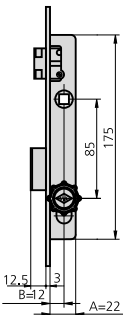
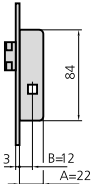
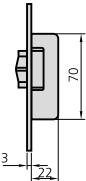
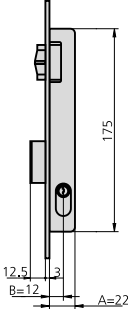
DESCRIPCIÓN	REF.	MEDIDAS		LEVA	ACABADOS		UDS	
		B	A		FRENTE	CILINDRO		
 <ul style="list-style-type: none"> <li>• Cerradura de pomo condena</li> <li>• Sin cilindro</li> </ul> <p><b>Opciones de cerradero</b></p> <ul style="list-style-type: none"> <li>• CE1984/6</li> </ul>	1963CP16/6	12	22		Al		1	20
 <ul style="list-style-type: none"> <li>• Cerradura de sólo picaporte</li> <li>• Sin cilindro</li> </ul> <p><b>Opciones de cerradero</b></p> <ul style="list-style-type: none"> <li>• CE196R/6L</li> </ul>	1963R/0	12	22		HN		2	60
 <ul style="list-style-type: none"> <li>• Cerradura de sólo vaivén</li> <li>• Sin cilindro</li> </ul> <p><b>Opciones de cerradero</b></p> <ul style="list-style-type: none"> <li>• CE196R/6L</li> </ul>	1963RV/0		22		HN		2	60
 <ul style="list-style-type: none"> <li>• Rodillo vaivén regulable y palanca</li> <li>• Cilindro 5963/2222</li> </ul> <p><b>Opciones de cerradero</b></p> <ul style="list-style-type: none"> <li>• CE1984/0 o CE1984/6</li> </ul>	1963V/0 1963V/5 1963V/6	12 12 12	22 22 22		HN HN Al	CN CL CN	1 1 1	20 20 20



**PALANCA DESLIZANTE ENTRE EJES 85 CILINDRO OVALADO MONOBLOCK**

**SERIE 1975**

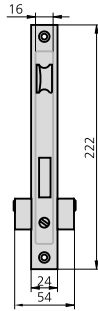

**CARACTERÍSTICAS**

- Frente de hierro niquelado
- Caja bicromatada
- Palanca deslizante
- Picaporte reversible
- Cuadradillo de 8 mm
- Cilindro ovalado monoblock (5963)
- 2 escudos de nylon ref. ES1963
- Tornillo de fijación de cilindro

**ACCESORIOS OPCIONALES**

- Cerraderos según cerradura (ver abajo)
- Cilindros (ver página 144)

DESCRIPCIÓN	REF.	MEDIDAS		LEVA	ACABADOS		UDS	
		B	A		FRENTE	CILINDRO		

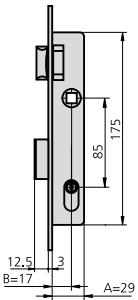

- Picaporte y palanca 1975/0
- Cilindro 5963/2222 1975/5

1975/0	17	29	HN	CN	1	20
1975/5	17	29	HN	CL	1	20

- Opciones de cerradero**
- CE1984/0

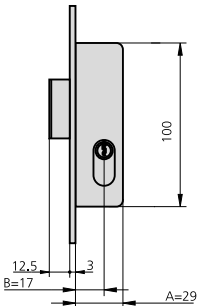

- Sólo palanca 1975A/0
- Cilindro 5963/2222 1975A/5

1975A/0	17	29	HN	CN	1	30
1975A/5	17	29	HN	CL	1	30

- Opciones de cerradero**
- CE2994S/6

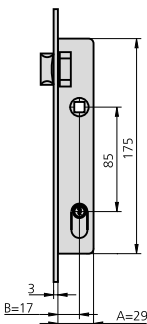

- Sólo picaporte 1975T/0
- Cilindro 5963T36 1975T/5

1975T/0	17	29	HN	CN	1	20
1975T/5	17	29	HN	CL	1	20

- Opciones de cerradero**
- CEC41T/6A o CEC41T/6AD

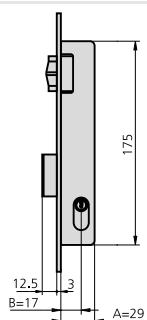

- Rodillo vaivén regulable y palanca 1975V/0
- Cilindro 5963/2222 1975V/5

1975V/0	17	29	HN	CN	1	20
1975V/5	17	29	HN	CL	1	20

- Opciones de cerradero**
- CE1984/0

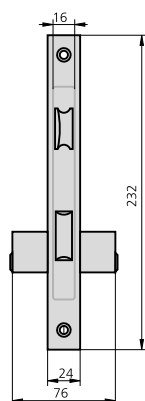
**CARACTERÍSTICAS**

- Frente de hierro niquelado o acero inoxidable
- Caja bicromatada
- Palanca deslizante
- Picaporte reversible
- Cuadradillo de 8 mm
- Cilindro ovalado monoblock (5964)
- 2 escudos de nylon ref. ES1964
- Tornillo de fijación de cilindro

**ACCESORIOS OPCIONALES**

- Cerraderos según cerradura (ver abajo)
- Cilindros (ver página 148)

DESCRIPCIÓN	REF.	MEDIDAS		LEVA	ACABADOS		UDS	
		B	A		FRENTE	CILINDRO		
<ul style="list-style-type: none"> <li>• Picaporte y palanca</li> <li>• Cilindro ovalado 5964/2525</li> </ul> <p><b>Opciones de cerradero</b></p> <ul style="list-style-type: none"> <li>• CE1984/0 o CE1984/6</li> </ul>	1964/0	20	34	HN	CN	1	20	
	1964/5	20	34	HN	CL	1	20	
	1964/6	20	34	AI	CN	1	20	
<ul style="list-style-type: none"> <li>• Cerradura de sólo palanca</li> <li>• Cilindro ovalado 5964/2525</li> </ul> <p><b>Opciones de cerradero</b></p> <ul style="list-style-type: none"> <li>• CE2994S/6</li> </ul>	1964A/0	20	34	HN	CN	1	30	
	1964A/5	20	34	HN	CL	1	30	
<ul style="list-style-type: none"> <li>• Cerradura de condena</li> <li>• Sin cilindro</li> </ul> <p><b>Opciones de cerradero</b></p> <ul style="list-style-type: none"> <li>• CE1984/0 o CE1984/6</li> </ul>	1964C/0	20	34	HN		2	40	
	1964C/6	20	34	AI		2	40	
<ul style="list-style-type: none"> <li>• Cerradura de pomo condena</li> <li>• Sin cilindro</li> </ul> <p><b>Opciones de cerradero</b></p> <ul style="list-style-type: none"> <li>• CE1984/6</li> </ul>	1964CP/6	20	34	AI		1	20	

**PALANCA DESLIZANTE ENTRE EJES 74 CILINDRO OVALADO DE VÁSTAGOS**

**SERIES 1964**

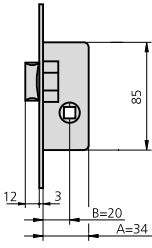
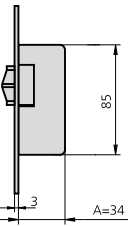
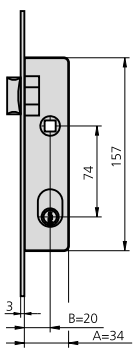
DESCRIPCIÓN	REF.	MEDIDAS		LEVA	ACABADOS		UDS	
		B	A		FRENTE	CILINDRO		
 <ul style="list-style-type: none"> <li>• Cerradura de sólo picaporte</li> <li>• Sin cilindro</li> </ul> <p><b>Opciones de cerradero</b></p> <ul style="list-style-type: none"> <li>• CE196R/6L</li> </ul>	1964R/0	20	34	HN		2	60	
	 <ul style="list-style-type: none"> <li>• Cerradura de sólo vaivén</li> <li>• Sin cilindro</li> </ul> <p><b>Opciones de cerradero</b></p> <ul style="list-style-type: none"> <li>• CE1975R/0</li> </ul>	1964RV/0		34	HN		2	60
 <ul style="list-style-type: none"> <li>• Cerradura de sólo picaporte</li> <li>• Cilindro 5964T25</li> </ul> <p><b>Opciones de cerraderos eléctricos</b></p> <ul style="list-style-type: none"> <li>• CEC41T/6A o CEC41T/6AD</li> </ul>	1964T/0	20	34	HN	CN	1	20	
	1964T/5	20	34	HN	CL	1	20	
	1964T/6	20	34	AI	CN	1	20	
	 <ul style="list-style-type: none"> <li>• Rodillo vaivén regulable y palanca</li> <li>• Cilindro 5964/2525</li> </ul> <p><b>Opciones de cerradero</b></p> <ul style="list-style-type: none"> <li>• CE1984/0 o CE1984/6</li> </ul>	1964V/0	20	34	HN	CN	1	20
1964V/5	20	34	HN	CL	1	20		
1964V/6	20	34	AI	CN	1	20		

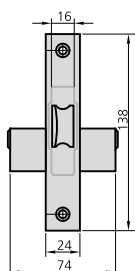
**CARACTERÍSTICAS**

- Frente de hierro niquelado
- Caja bicromatada
- Picaporte extensible y reversible
- Accionamiento extensible con llave
- Accionamiento del picaporte con llave y manilla
- Cuadradillo de 8 mm
- Cilindro ovalado monoblock (5081) o cilindro redondo monoblock (5181)
- 2 escudos de nylon ref. ES1964 ó ES1962/4
- Tornillo de fijación de cilindro
- Cerradero CE1991/0

**ACCESORIOS OPCIONALES**

- Cilindro (ver página 145)

DESCRIPCIÓN	REF.	MEDIDAS		LEVA	ACABADOS		UDS	
		B	A		FRENTE	CILINDRO		

**CILINDRO OVALADO**

- Cilindro ovalado 5081/3030
- Cerradero CE1991/0
- Escudo de nylon ES1964

1981/60/0	57	152	HN	CN	1	20
1981/60/5	57	152	HN	CL	1	20

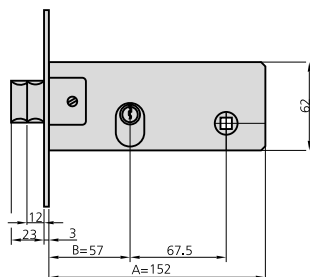
**CILINDRO REDONDO**

- Cilindro redondo 5181/3030
- Cerradero CE1991/0
- Escudo ES1962/4

11981/60/0	57	152	HN	CN	1	20
11981/60/5	57	152	HN	CL	1	20

**CILINDRO OVALADO**

- Vaivén extensible
- Cilindro ovalado 5081/3030
- Cerradero CE1991/0
- Escudo de nylon ES1964

1981V60/0	57	152	HN	CN	1	20
1981V60/5	57	152	HN	CL	1	20

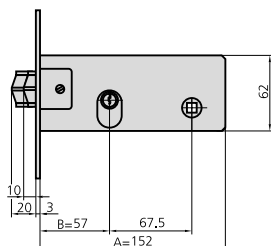

**CILINDRO REDONDO**

- Vaivén extensible
- Cilindro redondo 5181/3030
- Cerradero CE1991/0
- Escudo ES1962/4

11981V60/0	57	152	HN	CN	1	20
11981V60/5	57	152	HN	CL	1	20

**CERRADURA PARA PUERTAS DE ZÓCALO CON CILINDRO EUROPERFIL**

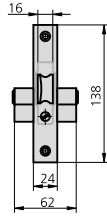
**SERIE 1991**



**CARACTERÍSTICAS**

- Frente de hierro niquelado
- Caja bicromatada
- Picaporte extensible y reversible
- Accionamiento extensible con llave
- Accionamiento del picaporte con llave y manilla
- Cuadradillo de 8 mm
- Cilindro europerfil
- 2 escudos de nylon ref. ES1984
- Tornillo de fijación de cilindro
- Cerradero CE1991/0

**ACCESORIOS OPCIONALES**

- Gama completa de cilindros (ver página 128 - 148)

DESCRIPCIÓN	REF.	MEDIDAS		LEVA	ACABADOS		UDS	
		B	A		FRENTE	CILINDRO		
• Picaporte extensible y reversible	1991/60/0	58	149	15	HN	CN	1	20
• Cilindro europerfil 5982/2525	1991/60/5	58	149	15	HN	CL	1	20
• Cerradero CE1991/0	1991/70/0	68	159	15	HN	CN	1	20
	1991/70/5	68	159	15	HN	CL	1	20

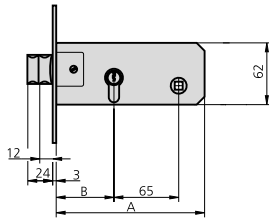

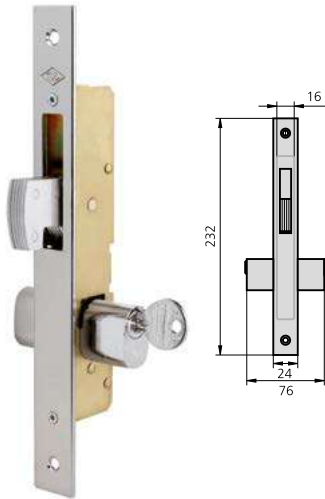
**CERRADURA DE SÓLO GANCHO CON CILINDRO OVALADO DE VÁSTAGOS**
**SERIE 1968**

**CARACTERÍSTICAS**

- Frente de hierro niquelado
- Caja bicromatada
- Palanca de gancho
- Cilindro ovalado monoblock de vástagos
- 2 escudos de nylon ref. ES1964
- Tornillo de fijación de cilindro

**ACCESORIOS OPCIONALES**

DESCRIPCIÓN	REF.	MEDIDAS		LEVA	ACABADOS		UDS	
		B	A		FRENTE	CILINDRO		
<ul style="list-style-type: none"> <li>• Cerradura con palanca basculante de gancho</li> <li>• Cilindro 5968/2525</li> </ul>	1968/0	17	34	HN	CN	1	20	
	1968/5	17	34	HN	CL	1	20	

**CERRADURA DE SÓLO GANCHO CON CILINDRO EUROPERFIL**

**SERIE 1982**

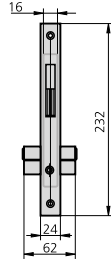



**CARACTERÍSTICAS**

- Frente de hierro niquelado
- Caja bicromatada
- Palanca de gancho
- Cilindro europerfil
- 2 escudos de nylon ref. ES1984
- Tornillo de fijación de cilindro

**ACCESORIOS OPCIONALES**

- Gama completa de cilindros (ver página 128 - 148)
- Cerraderos según cerradura (ver abajo)

DESCRIPCIÓN	REF.	MEDIDAS		LEVA	ACABADOS		UDS	
		B	A		FRENTE	CILINDRO		
<ul style="list-style-type: none"> <li>• Cerradura con palanca basculante de gancho</li> <li>• Cilindro 5982/2525</li> </ul>	1982/0	17	34		HN	CN	1	20
	1982/5	17	34		HN	CL	1	20

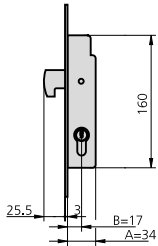

- Cerradura con palanca basculante de gancho
- Cilindro 5982/2525

**Opciones de cerradero**

- CE2994S/6

**CARACTERÍSTICAS**

- Frente de hierro niquelado
- Caja bicromatada
- Picaporte reversible accionado con llave por el exterior y con pomo por el interior o accionamiento con llave por ambos lados
- Cilindro ovalado monoblock de vástagos
- 2 escudos de nylon ref. ES1964
- Tornillo de fijación de cilindro

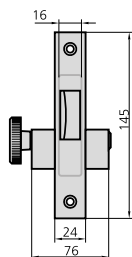
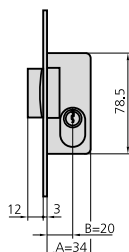
**ACCESORIOS OPCIONALES**

**DESCRIPCIÓN**
**REF.**
**MEDIDAS**
**LEVA**
**ACABADOS**
**UDS**
**B A**
**FRENTE CILINDRO**

- Picaporte reversible accionado con llave por el exterior y pomo por el interior
- 5979P3030

 1979P/0  
 1979P/5

 20 34  
 20 34

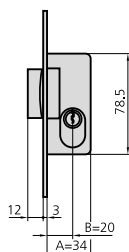
 HN CN  
 HN CL

 1 30  
 1 30

- Picaporte reversible accionado con llave por el exterior y por el interior
- 5979/3030

 1979/0  
 1979/5

 20 34  
 20 34

 HN CN  
 HN CL

 1 30  
 1 30



**CERRADURA PARA PUERTAS Y PERSIANAS METÁLICAS ENROLLABLES**

**SERIE 11A**



**CARACTERÍSTICAS**

- Cerradura para puertas metálicas enrollables
- Accionamiento exterior e interior mediante llave
- Caja bicromatada
- Cilindro redondo de 3 pitones

**ACCESORIOS OPCIONALES**

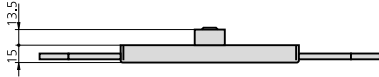
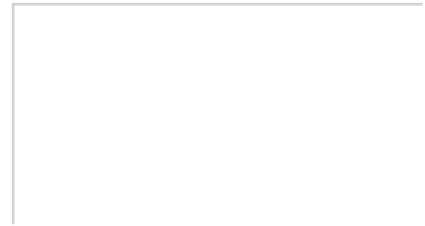

DESCRIPCIÓN	REF.	MEDIDAS		LEVA	ACABADOS		UDS	
		B	A		FRENTE	CILINDRO		
• Dos puntos de cierre laterales	11A	60	154		CL		1	24

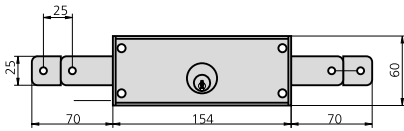

• Dos puntos de cierre laterales y un punto inferior	11A/3P	60	154		CL		1	
--	--------	----	-----	--	----	--	---	--

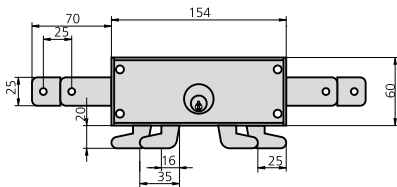

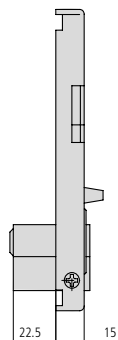

**CARACTERÍSTICAS**

- Accionamiento mediante manilla.
- Bloqueo interior mediante botón, bloqueo exterior mediante llave
- 2 puntos de cierre horizontales
- Caja bicromatada
- Medio cilindro monoblock ref. 5982T40/3
- Opcionalmente con set de escudo y manillas (ref. 11B/M)
- 1 Escudo ref. ES1960

**ACCESORIOS OPCIONALES**

- Gama completa de cilindros (ver página 128 - 148)

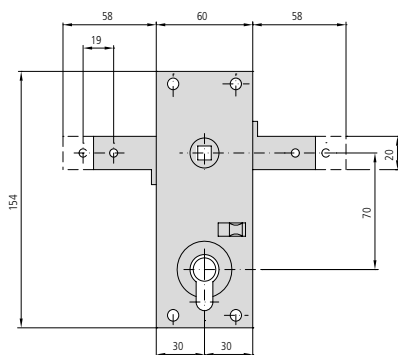
DESCRIPCIÓN	REF.	MEDIDAS		LEVA	ACABADOS		UDS	
		B	A		FRENTE	CILINDRO		
• Dos puntos de cierre horizontales	11B	60	154	15	CL		1	40
• Medio cilindro monoblock 5982T40/3	11B/M	60	154	15	CL		1	40



**ACCESORIOS**

**CERRADEROS PARA CERRADURAS METÁLICAS**

DESCRIPCIÓN	REF.	ACABADO	APLICABLE A CERRADURAS	UDS
-------------	------	---------	------------------------	-----

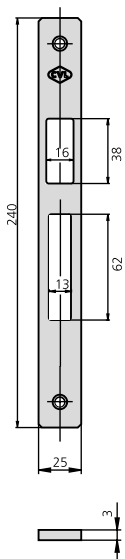

CE1983/6    Al    1983

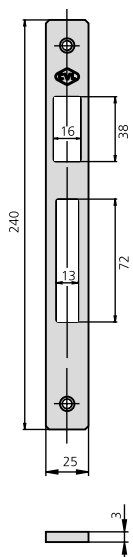

CE1984/0    HN  
 CE1984/6    Al    1984, 1992, 1995,  
 1964, 1963, 1975

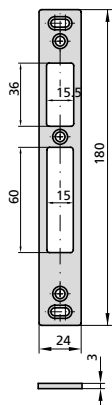

CE1984



CE190/0    HN  
 CE190/6    Al    190

**ACCESORIOS**

**CERRADEROS PARA CERRADURAS METÁLICAS**

DESCRIPCIÓN	REF.	ACABADO	APLICABLE A CERRADURAS	UDS  
-------------	------	---------	------------------------	---

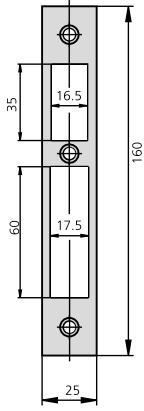

CE1990/0    HN    1990

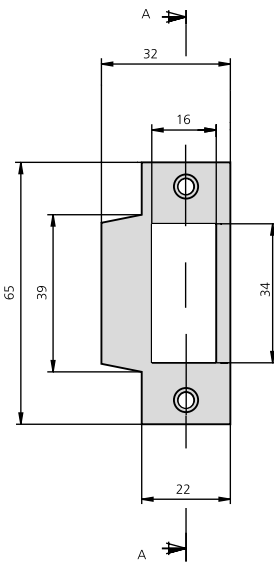
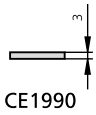

CE1991/0    HN    1991, 1981, 11981

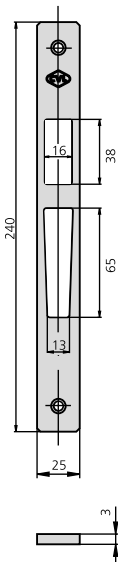

CE1994/6    Al    1994, 2994, 3994

ACCESORIOS

CERRADEROS PARA CERRADURAS METÁLICAS

DESCRIPCIÓN	REF.	ACABADO	APLICABLE A CERRADURAS	UDS
-------------	------	---------	------------------------	-----

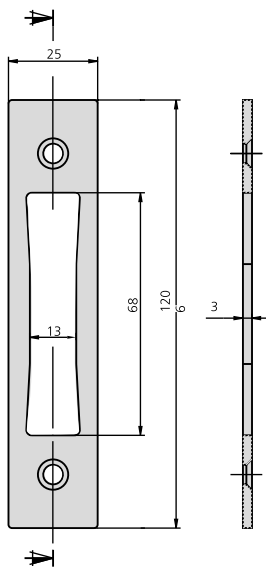

CE2994S/6

Al

1983A, 1963A, 1975A,  
1995A, arriba/abajo 2994,  
1982, 1968



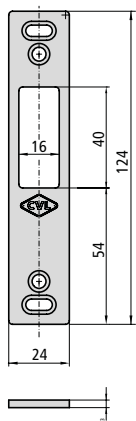

UDS



CE1975R/0

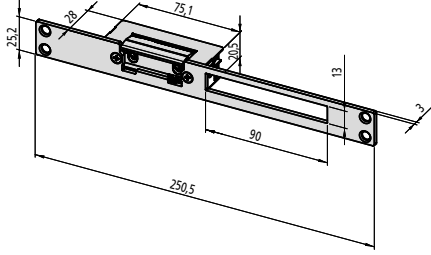
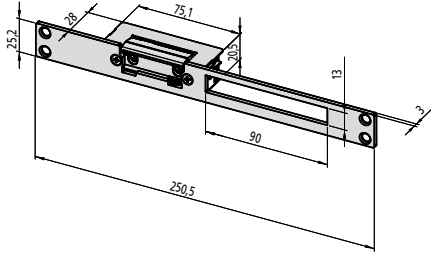
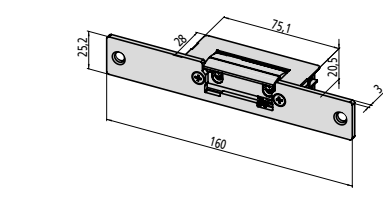
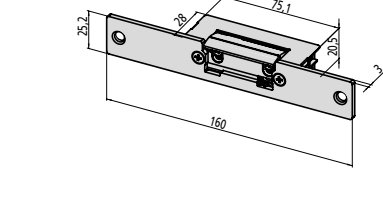

HN

1963R, 1963RV, 1964R,  
1964RV, 1964T, 1975R,  
1979R, 1983R, 1983RV,  
1983T, 1984T, 1992T,  
1995R, 1995T

DESCRIPCIÓN	REF.	APLICABLE A CERRADURAS	UDS  
<ul style="list-style-type: none"> <li>• Cerradero eléctrico regulable reversible con funcionamiento automático</li> <li>• Frente plano inox</li> <li>• 12V / corriente alterna</li> </ul>	CEL45/6A	1995, 1992, 1984, 190, 1990, 1994, 1983	
			
<ul style="list-style-type: none"> <li>• Cerradero eléctrico regulable reversible con funcionamiento automático y con desbloqueo</li> <li>• Frente plano inox</li> <li>• 12V / corriente alterna</li> </ul>	CEL45/6AD	1995, 1992, 1984, 190, 1990, 1994, 1983	
			
<ul style="list-style-type: none"> <li>• Cerradero eléctrico regulable reversible con funcionamiento automático</li> <li>• Sólo picaporte y frente plano inox</li> <li>• 12V / corriente alterna</li> </ul>	CEL45T/6A	1995T, 1992T, 1983T, 1984T	
			
<ul style="list-style-type: none"> <li>• Cerradero eléctrico regulable reversible con funcionamiento automático y con desbloqueo</li> <li>• Sólo picaporte y frente plano inox</li> <li>• 12V / corriente alterna</li> </ul>	CEL45T/6AD	1995T, 1992T, 1983T, 1984T	
			

ACCESORIOS

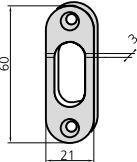
ESCUDOS

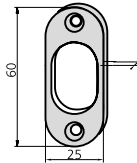
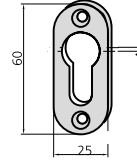
DESCRIPCIÓN	REF.	ACABADO	APLICABLE A CERRADURAS	UDS
	ES1963	Escudo de nylon	1963, 1975	 
	ES1964	Escudo de nylon	1964, 1968, 1979, 1981	
	ES1984	Escudo de nylon	1982, 1983, 1984, 1990, 1992, 1994, 1995, 196, 184, 183, 192, 194, 194, P194	



ACCESORIOS

ESCUDOS DE SEGURIDAD

DESCRIPCIÓN	REF.	ACABADO	APLICABLE A CERRADURAS	UDS
	BT194/1N	Negro	1983, 1984, 1990	 

ACCESORIOS

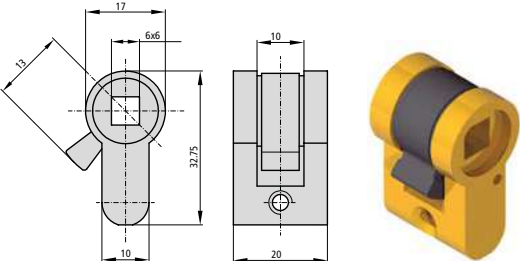
KIT CONDENA

DESCRIPCIÓN	REF.	APLICABLE A CERRADURAS	UDS
<ul style="list-style-type: none"> <li>Leva corta</li> </ul> 	5990C20	1983 (20-25-30) 1984 (20-25-30) 1992 (20-25-30)	 

## CERRADURAS DE SOBREPONER

	Cerradura de sobreponer serie 56	96
	• Serie 56A	96
	• Serie 56B	97
	• Serie 56C	98
	Cerradura de sobreponer serie 125	99
	• Serie 125A	99
	• Serie 125B	100
	Cerradura de sobreponer serie 124	101
	• Serie 124A	101
	Cerradura de sobreponer serie 122	102
	• Serie 122A	102
	• Serie 122C	103
	Cerradura de sobreponer serie 123	104
	• Serie 123A	104
	• Serie 123C	105
Cerrojos	106	
• Serie 1976	106	
• Serie 1978	107	
• Serie 1988	108	
Picaportes	109	
• Serie 234	109	
• Serie 236	110	
Alargamiento de cilindros	110	



CERRADURAS DE SOBREPONER

**CERRADURA DE SOBREPONER SERIE 56**

**SERIE 56A**

**CARACTERÍSTICAS**

- Picaporte accionado por llave exteriormente y con llave y tirador desde el interior
- Palanca de una vuelta de llave accionable por ambos lados
- Posibilidad de elección entre cilindro de perfil o cilindro redondo
- Dos acabados: hierro esmaltado y hierro niquelado
- Cerradero según cerradura
- Embellecedor según tipo de cilindro
- Componentes de sujeción

**ACCESORIOS OPCIONALES**

- Cilindro de seguridad

DESCRIPCIÓN	REF.	MEDIDAS		CILINDRO	ACABADOS		UDS		
		B	A		FRENTE	CILINDRO			
<ul style="list-style-type: none"> <li>• Cilindro perfil ref. 5056/50/3</li> <li>• Cerradero ref. CE56AD o CE56AI</li> <li>• Embellecedor ES125</li> </ul>	56A60D/0	35	60	5056/50/3	HN	CL	1	24	
	56A60I/0	35	60	5056/50/3	HN	CL	1	24	
	56A60D/1	35	60	5056/50/3	HE	CL	1	24	
	56A60I/1	35	60	5056/50/3	HE	CL	1	24	
	56A70D/0	45	70	5056/50/3	HN	CL	1	24	
	56A70I/0	45	70	5056/50/3	HN	CL	1	24	
	56A70D/1	45	70	5056/50/3	HE	CL	1	24	
	56A70I/1	45	70	5056/50/3	HE	CL	1	24	
	<ul style="list-style-type: none"> <li>• Cilindro redondo ref. 5156/50/3</li> <li>• Cerradero ref. CE56AD o CE56AI</li> <li>• Embellecedor ES1125</li> </ul>	156A60D/0	35	60	5156/50/3	HN	CL	1	24
		156A60I/0	35	60	5156/50/3	HN	CL	1	24
156A60D/1		35	60	5156/50/3	HE	CL	1	24	
156A60I/1		35	60	5156/50/3	HE	CL	1	24	
156A70D/0		45	70	5156/50/3	HN	CL	1	24	
156A70I/0		45	70	5156/50/3	HN	CL	1	24	
156A70D/1		45	70	5156/50/3	HE	CL	1	24	
156A70I/1		45	70	5156/50/3	HE	CL	1	24	

- 96 -

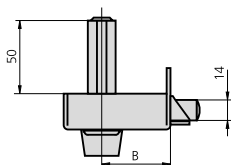

**CARACTERÍSTICAS**

- Picaporte accionado mediante manilla por ambos lados
- Palanca de una vuelta de llave accionable por ambos lados
- Posibilidad de elección entre cilindro de perfil o cilindro redondo
- Dos acabados: hierro esmaltado y hierro niquelado
- Cerradero según cerradura
- Embellecedor según tipo de cilindro
- Componentes de sujeción

**ACCESORIOS OPCIONALES**

- Cilindro de seguridad

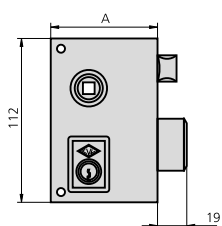
DESCRIPCIÓN	REF.	MEDIDAS		CILINDRO	ACABADOS		UDS	
		B	A		FRENTE	CILINDRO		
• Cilindro perfil ref. 5056/50/3	56B60D/0	35	60	5056/50/3	HN	CL	1	24
• Cerradero ref. CE56AD o CE56AI	56B60I/0	35	60	5056/50/3	HN	CL	1	24
• Embellecedor ES125	56B60D/1	35	60	5056/50/3	HE	CL	1	24
	56B60I/1	35	60	5056/50/3	HE	CL	1	24
	56BR70D/0	45	70	5056/50/3	HN	CL	1	24
	56BR70I/0	45	70	5056/50/3	HN	CL	1	24
	56BR70D/1	45	70	5056/50/3	HE	CL	1	24
	56BR70I/1	45	70	5056/50/3	HE	CL	1	24



• Cilindro redondo ref. 5156/50/3	156B60D/0	35	60	5156/50/3	HN	CL	1	24
• Cerradero ref. CE56AD o CE56AI	156B60I/0	35	60	5156/50/3	HN	CL	1	24
• Embellecedor ES1125	156B60D/1	35	60	5156/50/3	HE	CL	1	24
	156B60I/1	35	60	5156/50/3	HE	CL	1	24
	156BR70D/0	45	70	5156/50/3	HN	CL	1	24
	156BR70I/0	45	70	5156/50/3	HN	CL	1	24
	156BR70D/1	45	70	5156/50/3	HE	CL	1	24
	156BR70I/1	45	70	5156/50/3	HE	CL	1	24

CERRADURAS DE SOBREPONER

**CERRADURA DE SOBREPONER SERIE 56**

**SERIE 56C**

**CARACTERÍSTICAS**

- Picaporte accionado por manilla por ambos lados
- Palanca de una vuelta de llave accionable por ambos lados
- Posibilidad de elección entre cilindro de perfil o cilindro redondo
- Dos acabados: hierro esmaltado y hierro niquelado
- Cerradero según cerradura
- Embellecedor según tipo de cilindro
- Componentes de sujeción

**ACCESORIOS OPCIONALES**

- Cilindro de seguridad

DESCRIPCIÓN	REF.	MEDIDAS		CILINDRO	ACABADOS		UDS		
		B	A		FRENTE	CILINDRO			
<ul style="list-style-type: none"> <li>• Cilindro perfil ref. 5056/50/3</li> <li>• Cerradero ref. CE56C/1 o CE56C/0</li> <li>• Embellecedor ES125</li> </ul>	56C60D/0	35	60	5056/50/3	HN	CL	1	24	
	56C60I/0	35	60	5056/50/3	HN	CL	1	24	
	56C60D/1	35	60	5056/50/3	HE	CL	1	24	
	56C60I/1	35	60	5056/50/3	HE	CL	1	24	
	56C70D/0	45	70	5056/50/3	HN	CL	1	24	
	56C70I/0	45	70	5056/50/3	HN	CL	1	24	
	56C70D/1	45	70	5056/50/3	HE	CL	1	24	
	56C70I/1	45	70	5056/50/3	HE	CL	1	24	
	<ul style="list-style-type: none"> <li>• Cilindro redondo ref. 5156/50/3</li> <li>• Cerradero ref. CE56C/1 o CE56C/0</li> <li>• Embellecedor ES1125</li> </ul>	156C60D/0	35	60	5156/50/3	HN	CL	1	24
		156C60I/0	35	60	5156/50/3	HN	CL	1	24
156C60D/1		35	60	5156/50/3	HE	CL	1	24	
156C60I/1		35	60	5156/50/3	HE	CL	1	24	
156C70D/0		45	70	5156/50/3	HN	CL	1	24	
156C70I/0		45	70	5156/50/3	HN	CL	1	24	
156C70D/1		45	70	5156/50/3	HE	CL	1	24	
156C70I/1		45	70	5156/50/3	HE	CL	1	24	

- 98 -

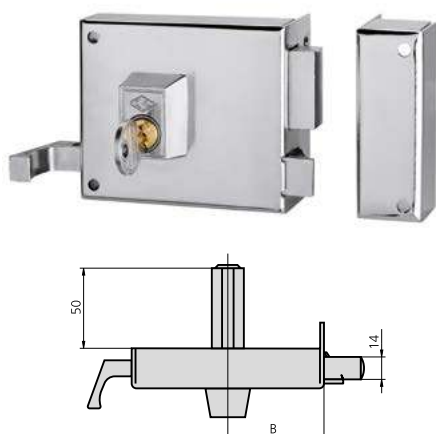

**CARACTERÍSTICAS**

- Picaporte accionado por llave exteriormente y con llave y tirador desde el interior
- Palanca de dos vueltas de llave accionable por ambos lados
- Posibilidad de elección entre cilindro de perfil o cilindro redondo
- Dos acabados: hierro esmaltado y hierro niquelado
- Cerradero según cerradura
- Embellecedor según tipo de cilindro
- Componentes de sujeción

**ACCESORIOS OPCIONALES**

- Cilindro de seguridad

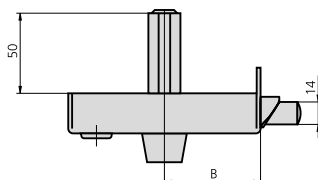
DESCRIPCIÓN	REF.	MEDIDAS		CILINDRO	ACABADOS		UDS	
		B	A		FRENTE	CILINDRO		
<ul style="list-style-type: none"> <li>• Cilindro perfil ref. 5056/50/3</li> <li>• Picaporte reversible en la medida de 100 mm (REF. 125AR)</li> <li>• Cerradero ref. CE125AD o CE125AI</li> <li>• Embellecedor ES125</li> </ul>	125A8D/0	47	90	5056/50/3	HN	CL	1	20
	125A8I/0	47	90	5056/50/3	HN	CL	1	20
	125A8D/1	47	90	5056/50/3	HE	CL	1	20
	125A8I/1	47	90	5056/50/3	HE	CL	1	20
	125AR10D/0	60	100	5056/50/3	HN	CL	1	20
	125AR10I/0	60	100	5056/50/3	HN	CL	1	20
	125AR10D/1	60	100	5056/50/3	HE	CL	1	20
	125AR10I/1	60	100	5056/50/3	HE	CL	1	20
	125A12D/0	60	120	5056/50/3	HN	CL	1	20
	125A12I/0	60	120	5056/50/3	HN	CL	1	20
	125A12D/1	60	120	5056/50/3	HE	CL	1	20
	125A12I/1	60	120	5056/50/3	HE	CL	1	20
	125A14D/0	70	140	5056/50/3	HN	CL	1	20
	125A14I/0	70	140	5056/50/3	HN	CL	1	20
125A14D/1	70	140	5056/50/3	HE	CL	1	20	
125A14I/1	70	140	5056/50/3	HE	CL	1	20	
<ul style="list-style-type: none"> <li>• Cilindro redondo ref. 5156/50/3</li> <li>• Picaporte reversible en la medida de 100 mm (REF. 1125AR)</li> <li>• Cerradero ref. CE125AD o CE125AI</li> <li>• Embellecedor ES1125</li> </ul>	1125A8D/0	47	90	5156/50/3	HN	CL	1	20
	1125A8I/0	47	90	5156/50/3	HN	CL	1	20
	1125A8D/1	47	90	5156/50/3	HE	CL	1	20
	1125A8I/1	47	90	5156/50/3	HE	CL	1	20
	1125AR10D/0	60	100	5156/50/3	HN	CL	1	20
	1125AR10I/0	60	100	5156/50/3	HN	CL	1	20
	1125AR10D/1	60	100	5156/50/3	HE	CL	1	20
	1125AR10I/1	60	100	5156/50/3	HE	CL	1	20
	1125A12D/0	60	120	5156/50/3	HN	CL	1	20
	1125A12I/0	60	120	5156/50/3	HN	CL	1	20
	1125A12D/1	60	120	5156/50/3	HE	CL	1	20
	1125A12I/1	60	120	5156/50/3	HE	CL	1	20
	1125A14D/0	70	140	5156/50/3	HN	CL	1	20
	1125A14I/0	70	140	5156/50/3	HN	CL	1	20
1125A14D/1	70	140	5156/50/3	HE	CL	1	20	
1125A14I/1	70	140	5156/50/3	HE	CL	1	20	



CARACTERÍSTICAS

- Picaporte accionado por manilla por ambos lados
- Picaporte reversible
- Palanca de dos vueltas de llave accionable por ambos lados
- Posibilidad de elección entre cilindro de perfil o cilindro redondo
- Dos acabados: hierro esmaltado y hierro niquelado
- Cerradero según cerradura
- Embellecedor según tipo de cilindro
- Componentes de sujeción

ACCESORIOS OPCIONALES

- Cilindro de seguridad

DESCRIPCIÓN	REF.	MEDIDAS		CILINDRO	ACABADOS		UDS	
		B	A		FRENTE	CILINDRO		
<ul style="list-style-type: none"> <li>• Cilindro perfil ref. 5056/50/3</li> <li>• Picaporte reversible</li> <li>• Cerradero ref. CE125AD o CE125AI</li> <li>• Embellecedor ES125</li> </ul>	125BR12D/0	60	120	5056/50/3	HN	CL	1	24
	125BR12I/0	60	120	5056/50/3	HN	CL	1	24
	125BR12D/1	60	120	5056/50/3	HE	CL	1	24
	125BR12I/1	60	120	5056/50/3	HE	CL	1	24
	125BR14D/0	70	140	5056/50/3	HN	CL	1	24
	125BR14I/0	70	140	5056/50/3	HN	CL	1	24
	125BR14D/1	70	140	5056/50/3	HE	CL	1	24
	125BR14I/1	70	140	5056/50/3	HE	CL	1	24

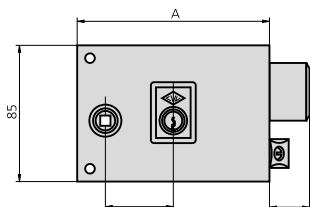

- Cilindro redondo ref. 5156/50/3
- Picaporte reversible
- Cerradero ref. CE125AD o CE125AI
- Embellecedor ES1125

	1125BR12D/0	60	120	5156/50/3	HN	CL	1	24
	1125BR12I/0	60	120	5156/50/3	HN	CL	1	24
	1125BR12D/1	60	120	5156/50/3	HE	CL	1	24
	1125BR12I/1	60	120	5156/50/3	HE	CL	1	24
	1125BR14D/0	70	140	5156/50/3	HN	CL	1	24
	1125BR14I/0	70	140	5156/50/3	HN	CL	1	24
	1125BR14D/1	70	140	5156/50/3	HE	CL	1	24
	1125BR14I/1	70	140	5156/50/3	HE	CL	1	24

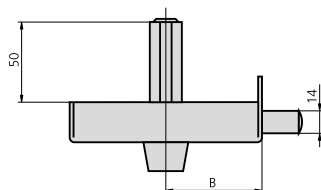

**CARACTERÍSTICAS**

- Palanca de dos vueltas de llave accionable por ambos lados
- Posibilidad de elección entre cilindro de perfil o cilindro redondo
- Dos acabados: hierro esmaltado y hierro niquelado
- Cerradero según cerradura
- Embellecedor según tipo de cilindro
- Componentes de sujeción

**ACCESORIOS OPCIONALES**

- Cilindro de seguridad

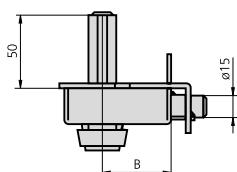
DESCRIPCIÓN	REF.	MEDIDAS		CILINDRO	ACABADOS		UDS	
		B	A		FRENTE	CILINDRO		
<ul style="list-style-type: none"> <li>• Cilindro perfil ref. 5056/50/3</li> <li>• Cerradero ref. CE125AD o CE125AI</li> <li>• Embellecedor ES125</li> </ul>	124A8D/0	47	90	5056/50/3	HN	CL	1	24
	124A8I/0	47	90	5056/50/3	HN	CL	1	24
	124A8D/1	47	90	5056/50/3	HE	CL	1	24
	124A8I/1	47	90	5056/50/3	HE	CL	1	24
	124A10D/0	60	100	5056/50/3	HN	CL	1	24
	124A10I/0	60	100	5056/50/3	HN	CL	1	24
	124A10D/1	60	100	5056/50/3	HE	CL	1	24
	124A10I/1	60	100	5056/50/3	HE	CL	1	24
	124A12D/0	60	120	5056/50/3	HN	CL	1	24
	124A12I/0	60	120	5056/50/3	HN	CL	1	24
	124A12D/1	60	120	5056/50/3	HE	CL	1	24
	124A12I/1	60	120	5056/50/3	HE	CL	1	24
<ul style="list-style-type: none"> <li>• Cilindro redondo ref. 5156/50/3</li> <li>• Cerradero ref. CE125AD o CE125AI</li> <li>• Embellecedor ES1125</li> </ul>	124A14D/0	70	140	5056/50/3	HN	CL	1	24
	124A14I/0	70	140	5056/50/3	HN	CL	1	24
	124A14D/1	70	140	5056/50/3	HE	CL	1	24
	124A14I/1	70	140	5056/50/3	HE	CL	1	24
	1124A8D/0	47	90	5156/50/3	HN	CL	1	24
	1124A8I/0	47	90	5156/50/3	HN	CL	1	24
	1124A8D/1	47	90	5156/50/3	HE	CL	1	24
	1124A8I/1	47	90	5156/50/3	HE	CL	1	24
	1124A10D/0	60	100	5156/50/3	HN	CL	1	24
	1124A10I/0	60	100	5156/50/3	HN	CL	1	24
	1124A10D/1	60	100	5156/50/3	HE	CL	1	24
	1124A10I/1	60	100	5156/50/3	HE	CL	1	24
1124A12D/0	60	120	5156/50/3	HN	CL	1	24	
1124A12I/0	60	120	5156/50/3	HN	CL	1	24	
1124A12D/1	60	120	5156/50/3	HE	CL	1	24	
1124A12I/1	60	120	5156/50/3	HE	CL	1	24	
1124A14D/0	70	140	5156/50/3	HN	CL	1	24	
1124A14I/0	70	140	5156/50/3	HN	CL	1	24	
1124A14D/1	70	140	5156/50/3	HE	CL	1	24	
1124A14I/1	70	140	5156/50/3	HE	CL	1	24	



**CARACTERÍSTICAS**

- Cerradura de sobreponer reforzada
- Picaporte accionado por llave exteriormente y con llave o pomo desde el interior
- Palanca de 3 bulones de acero a dos vueltas de llave accionable por ambos lados del cilindro
- Sistema antipalanqueta
- Posibilidad de elección entre cilindro de perfil o cilindro redondo
- Dos acabados: hierro esmaltado y hierro niquelado
- Cerradero según cerradura
- Embellecedor según tipo de cilindro
- Componentes de sujeción

**ACCESORIOS OPCIONALES**

- Cilindro de seguridad

**DESCRIPCIÓN**

**REF.**

**MEDIDAS**

**CILINDRO**

**ACABADOS**

**UDS**

**B**

**A**

**FRENTE**

**CILINDRO**



- Cilindro perfil ref. 5056/50/3
- Cerradero ref. CE122AD o CE122AI
- Embellecedor ES125

122A70D/0	45	70	5056/50/3	HN	CL	1	10
122A70I/0	45	70	5056/50/3	HN	CL	1	10
122A70D/1	45	70	5056/50/3	HE	CL	1	10
122A70I/1	45	70	5056/50/3	HE	CL	1	10

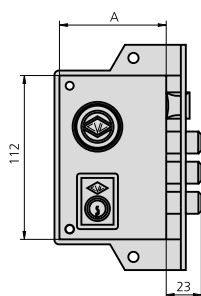

- Cilindro redondo ref. 5156/50/3
- Cerradero ref. CE122AD o CE122AI
- Embellecedor ES1125

1122A70D/0	45	70	5156/50/3	HN	CL	1	10
1122A70I/0	45	70	5156/50/3	HN	CL	1	10
1122A70D/1	45	70	5156/50/3	HE	CL	1	10
1122A70I/1	45	70	5156/50/3	HE	CL	1	10

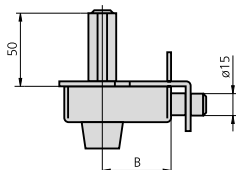
**CARACTERÍSTICAS**

- Cerradura de sobreponer reforzada
- Palanca de 4 bulones de acero a dos vueltas de llave accionable por ambos lados del cilindro
- Sistema antipalanqueta
- Posibilidad de elección entre cilindro de perfil o cilindro redondo
- Dos acabados: hierro esmaltado y hierro niquelado
- Cerradero según cerradura
- Embellecedor según tipo de cilindro
- Componentes de sujeción

**ACCESORIOS OPCIONALES**

- Cilindro de seguridad

**DESCRIPCIÓN**
**REF.**
**MEDIDAS**
**CILINDRO**
**ACABADOS**
**UDS**
**B**
**A**
**FRENTE**
**CILINDRO**

- Cilindro perfil ref. 5056/50/3
- Cerradero ref. CE122C/1 o CE122C/0
- Embellecedor ES125

122C70D/0

45

70

5056/50/3

HN

CL

1

10

122C70I/0

45

70

5056/50/3

HN

CL

1

10

122C70D/1

45

70

5056/50/3

HE

CL

1

10

122C70I/1

45

70

5056/50/3

HE

CL

1

10

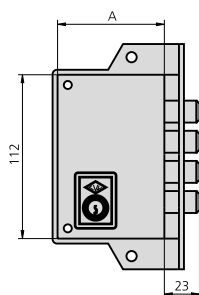

- Cilindro redondo ref. 5156/50/3
- Cerradero ref. CE122C/1 o CE122C/0
- Embellecedor ES1125

1122C70D/0

45

70

5156/50/3

HN

CL

1

10

1122C70I/0

45

70

5156/50/3

HN

CL

1

10

1122C70D/1

45

70

5156/50/3

HE

CL

1

10

1122C70I/1

45

70

5156/50/3

HE

CL

1

10



CERRADURAS DE SOBREPONER

**CERRADURA DE SOBREPONER SERIE 123**

**SERIE 123A**

**CARACTERÍSTICAS**

- Cerradura de sobreponer reforzada
- Picaporte accionable mediante llave por el exterior y con tirador o llave desde el interior
- Palanca de 3 bulones de acero a dos vueltas de llave accionable por ambos lados del cilindro
- Sistema antipalanqueta
- Posibilidad de elección entre cilindro de perfil o cilindro redondo
- Dos acabados: hierro esmaltado y hierro niquelado
- Cerradero según cerradura
- Embellecedor según tipo de cilindro
- Componentes de sujeción

**ACCESORIOS OPCIONALES**

- Cilindro de seguridad

DESCRIPCIÓN	REF.	MEDIDAS		CILINDRO	ACABADOS		UDS	
		B	A		FRENTE	CILINDRO		
• Cilindro perfil ref. 5056/50/3	123A10D/0	60	100	5056/50/3	HN	CL	1	10
• Cerradero ref. CE123AD o CE123AI	123A10I/0	60	100	5056/50/3	HN	CL	1	10
• Embellecedor ES125	123A10D/1	60	100	5056/50/3	HE	CL	1	10
	123A10I/1	60	100	5056/50/3	HE	CL	1	10
	123A12D/0	60	120	5056/50/3	HN	CL	1	10
	123A12I/0	60	120	5056/50/3	HN	CL	1	10
	123A12D/1	60	120	5056/50/3	HE	CL	1	10
	123A12I/1	60	120	5056/50/3	HE	CL	1	10

• Cilindro redondo ref. 5156/50/3	1123A10D/0	60	100	5156/50/3	HN	CL	1	10
• Cerradero ref. CE123AD o CE123AI	1123A10I/0	60	100	5156/50/3	HN	CL	1	10
• Embellecedor ES1125	1123A10D/1	60	100	5156/50/3	HE	CL	1	10
	1123A10I/1	60	100	5156/50/3	HE	CL	1	10
	1123A12D/0	60	120	5156/50/3	HN	CL	1	10
	1123A12I/0	60	120	5156/50/3	HN	CL	1	10
	1123A12D/1	60	120	5156/50/3	HE	CL	1	10
	1123A12I/1	60	120	5156/50/3	HE	CL	1	10

- 104 -

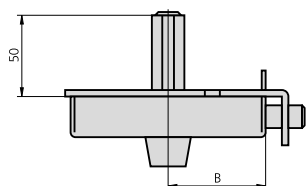
**CARACTERÍSTICAS**

- Cerradura de sobreponer reforzada
- Palanca de 4 bulones de acero a dos vueltas de llave accionable por ambos lados del cilindro
- Sistema antipalanqueta
- Posibilidad de elección entre cilindro de perfil o cilindro redondo
- Dos acabados: hierro esmaltado y hierro niquelado
- Cerradero según cerradura
- Embellecedor según tipo de cilindro
- Componentes de sujeción

**ACCESORIOS OPCIONALES**

- Cilindro de seguridad

**DESCRIPCIÓN**
**REF.**
**MEDIDAS**
**CILINDRO**
**ACABADOS**
**UDS**
**B**
**A**
**FRENTE**
**CILINDRO**

- Cilindro perfil ref. 5056/50/3
- Cerradero ref. CE123C/1 o CE123C/1
- Embellecedor ES125

123C10D/0	60	100	5056/50/3	HN	CL	1	10
123C10I/0	60	100	5056/50/3	HN	CL	1	10
123C10D/1	60	100	5056/50/3	HE	CL	1	10
123C10I/1	60	100	5056/50/3	HE	CL	1	10
123C12D/0	60	120	5056/50/3	HN	CL	1	10
123C12I/0	60	120	5056/50/3	HN	CL	1	10
123C12D/1	60	120	5056/50/3	HE	CL	1	10
123C12I/1	60	120	5056/50/3	HE	CL	1	10

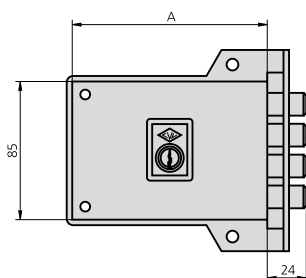

- Cilindro redondo ref. 5156/50/3
- Cerradero ref. CE123C/1 o CE123C/1
- Embellecedor ES1125

1123C10D/0	60	100	5156/50/3	HN	CL	1	10
1123C10I/0	60	100	5156/50/3	HN	CL	1	10
1123C10D/1	60	100	5156/50/3	HE	CL	1	10
1123C10I/1	60	100	5156/50/3	HE	CL	1	10
1123C12D/0	60	120	5156/50/3	HN	CL	1	10
1123C12I/0	60	120	5156/50/3	HN	CL	1	10
1123C12D/1	60	120	5156/50/3	HE	CL	1	10
1123C12I/1	60	120	5156/50/3	HE	CL	1	10

## CERROJOS

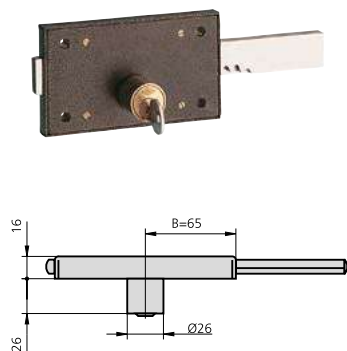

## SERIE 1976



### CARACTERÍSTICAS

- Cerrojo de seguridad reversible aplicable a puertas metálicas basculantes o enrollables
- Se suministra por parejas con la misma llave
- Palanca deslizante de acero accionable por llave desde el exterior
- Cilindro exterior redondo diámetro 26 mm
- Acabado en hierro esmaltado

### ACCESORIOS OPCIONALES

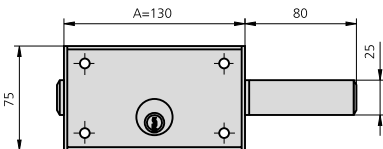
DESCRIPCIÓN	REF.	MEDIDAS		CILINDRO	ACABADOS		UDS	
		B	A		FRENTE	CILINDRO		
	1976/1	65	130	Ø 26mm	HE	CL	1	17

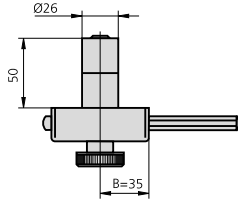
**CARACTERÍSTICAS**

- Cerrojo de seguridad reversible
- Palanca deslizante de acero accionable por llave desde el exterior y mediante pomo desde el interior
- Cilindro exterior redondo diámetro 26 mm
- Dos acabados: hierro esmaltado y hierro niquelado
- Cerradero CE1978/1 o CE1978/0
- Embellecedor ES1125
- Componentes de sujeción

**ACCESORIOS OPCIONALES**

- Cilindro de seguridad
- Cilindros de distintas longitudes

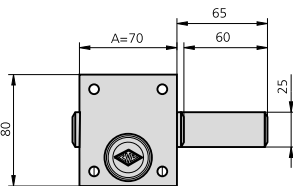
**DESCRIPCIÓN**
**REF.**
**MEDIDAS**
**CILINDRO**
**ACABADOS**
**UDS**
**B**
**A**
**FRENTE**
**CILINDRO**

1978/0

35

70

Ø 26mm

HN

CL

1

20

1978/1

35

70

Ø 26mm

HE

CL

1

20

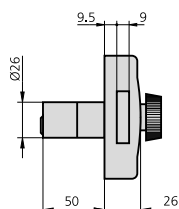

CARACTERÍSTICAS

- Cerrojo de seguridad reversible
- Palanca deslizante de acero accionable por llave desde el exterior y mediante pomo desde el interior
- Cilindro exterior redondo diámetro 26 mm
- Dos acabados: hierro esmaltado y hierro niquelado
- Cerradero CE1988/1 o CE1988/0
- Embellecedor ES1125
- Componentes de sujeción

ACCESORIOS OPCIONALES

- Cilindro de seguridad
- Cilindros de distintas longitudes

DESCRIPCIÓN

REF.

MEDIDAS  
B A

CILINDRO  
Ø

ACABADOS  
FRENTE CILINDRO



UDS

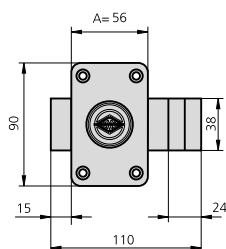

1988/0	56	Ø 26mm	HN	CL	1	24
1988/1	56	Ø 26mm	HE	CL	1	24

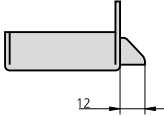
**CARACTERÍSTICAS**

- Picaporte reversible de sobreponer
- Picaporte accionable mediante manilla
- Cuadradillo para manilla de 8 mm
- Acabado en hierro esmaltado
- Cerradero CE234/1
- Embellecedor ES234

**ACCESORIOS OPCIONALES**

DESCRIPCIÓN	REF.	MEDIDAS		CILINDRO	ACABADOS		UDS	
		B	A		FRENTE	CILINDRO		
	234/50/1	30	50	-	HE	-	6	120
	234/60/1	38	60	-	HE	-	6	120
	234/70/1	46	70	-	HE	-	6	120

**PICAPORTES**

**SERIE 236**



**CARACTERÍSTICAS**

- Picaporte reversible de sobreponer
- Condena accionable mediante tirador
- Cuadradillo para manilla de 8 mm
- Acabado en hierro esmaltado
- Cerradero CE236/1
- Embellecedor ES234

**ACCESORIOS OPCIONALES**

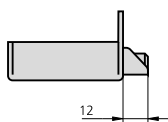

**DESCRIPCIÓN**

**REF.**

**MEDIDAS**

**CILINDRO**

**ACABADOS**

**UDS**

**B**

**A**

**FRENTE**

**CILINDRO**

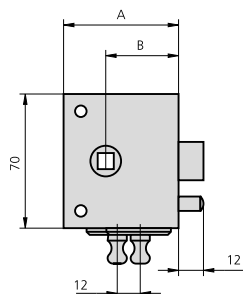

236/50/1

30

50

-

HE

6

120

236/60/1

38

60

-

HE

6

120

236/70/1

46

70

-

HE

6

120

**ALARGAMIENTO DE CILINDROS**

**SOBREPONER**

- Kit 5156/60 para cilindro redondo de cerradura de sobreponer
- Kit 5156/70 para cilindro redondo de cerradura de sobreponer
- Kit 5156/80 para cilindro redondo de cerradura de sobreponer

- Recargo alargamiento de cilindro redondo (60, 70, 80) para cerradura de sobreponer
- Recargo alargamiento de cilindro redondo (90, 100, 110) para cerradura de sobreponer

## CERRADURAS DE EMBUTIR PARA CARPINTERÍA DE MADERA

Cerraduras de seguridad con palanca de bulones	112
• Serie 4000	112
Cerradura multipunto de seguridad con palanca de bulones	113
• Serie 4100	113
Cerraduras de palanca rectangular deslizante	114
• Serie 1985N	114
• Serie 1970N	115
• Serie 1960	117
• Serie 1961	118
• Serie 1962	119
Picaportes	120
• Serie 249	120
Accesorios	121
• Cerraderos	121
• Escudos	123
• Escudos de seguridad	123
• Kit condena	124



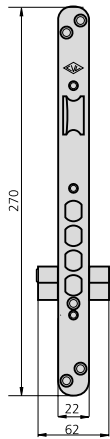

CARACTERÍSTICAS

- Cerradura de seguridad de 1 punto y palanca de 4 bulones de acero
- Entre ejes 85 mm
- Frente de hierro latonado o acero inoxidable disponible en canto redondo y canto cuadrado
- Picaporte reversible accionable mediante llave y manilla
- Cerradero de hierro latonado o acero inoxidable disponible en canto redondo y canto cuadrado
- Escudo protector de cilindro
- Cilindro de seguridad
- Otros acabados posibles: inox, pintado bronce ingles, pintado dorado, pintado plateado

ACCESORIOS OPCIONALES

- Gama completa de cilindros (ver página 128 - 148)

DESCRIPCIÓN	REF.	MEDIDAS		LEVA	ACABADOS		CANTO	UDS	
		B	A		FRENTE	CILINDRO			

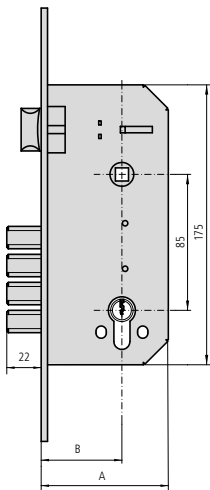

• Picaporte y palanca de 4 bulones de acero	4000/50/0	50	80	15	HN	CN	Red	1	12
	4000/50/6	50	80	15	AI	CN	Red	1	12
• Cilindro de seguridad 6982/2525	4001/50/0	50	80	15	HN	CN	Cua	1	12
	4001/50/6	50	80	15	AI	CN	Cua	1	12
	4000/60/0	60	90	15	HN	CN	Red	1	12
	4000/60/6	60	90	15	AI	CN	Red	1	12
	4001/60/0	60	90	15	HN	CN	Cua	1	12
	4001/60/6	60	90	15	AI	CN	Cua	1	12

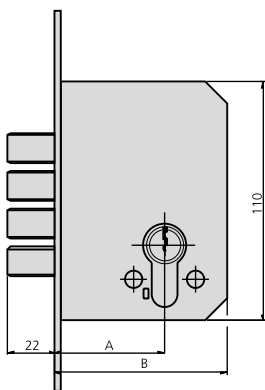

• Cerradura con sólo palanca de 4 bulones de acero	4000A50/0	50	80	15	HN	CN	Red	1	12
	4000A50/6	50	80	15	AI	CN	Red	1	12
• Cilindro de seguridad 6982/2525	4001A50/0	50	80	15	HN	CN	Cua	1	12
	4001A50/6	50	80	15	AI	CN	Cua	1	12
	4000A60/0	60	90	15	HN	CN	Red	1	12
	4000A60/6	60	90	15	AI	CN	Red	1	12
	4001A60/0	60	90	15	HN	CN	Cua	1	12
	4001A60/6	60	90	15	AI	CN	Cua	1	12

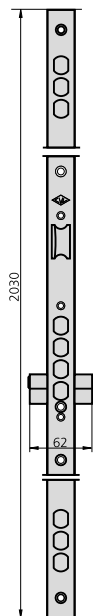
**CARACTERÍSTICAS**

- Cerradura de alta seguridad de 3 puntos de cierre mediante 10 bulones de acero
- Entre ejes 85 mm
- Frente largo de acero niquelado
- Picaporte reversible accionable mediante llave y manilla
- 3 cerraderos cortos de acero niquelado
- Escudo protector de cilindro de seguridad pintado dorado
- Cilindro de seguridad
- Otros acabados posibles: inox, pintado bronce ingles, pintado dorado, pintado plateado

**ACCESORIOS OPCIONALES**

- Gama completa de cilindros (ver página 128 - 148)

DESCRIPCIÓN	REF.	MEDIDAS		LEVA	ACABADOS		UDS	
		B	A		FRENTE	CILINDRO		

- Cerradura de 3 puntos 4100/50/0
- Cilindro de seguridad ref. 6982/2525/4

4100/50/0	50	80	15	HN			1
4100/60/0	60	90	15	HN			1

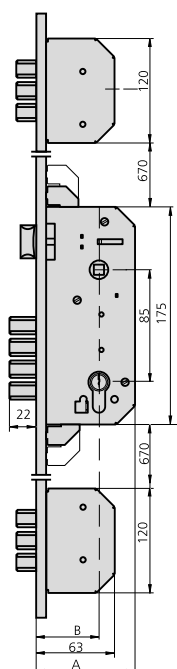

## CERRADURAS DE PALANCA RECTANGULAR DESLIZANTE

## SERIE 1985N

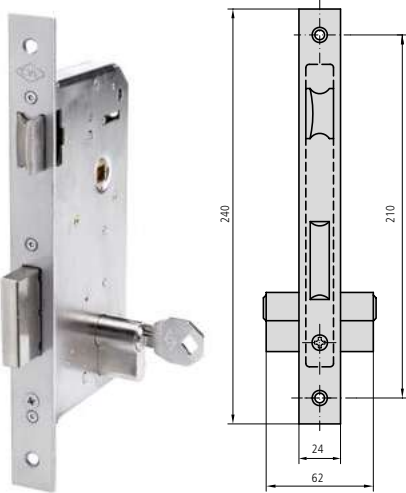

### CARACTERÍSTICAS

- Entre ejes 85 mm
- Frente de hierro latonado o acero inoxidable
- Picaporte reversible accionable mediante llave y manilla
- Palanca deslizante a dos vueltas de llave
- Cerradero según cerradura
- Embellecedor ES1960
- Componentes de sujeción
- Cilindro euoperfil

### ACCESORIOS OPCIONALES

- Gama completa de cilindros (ver página 128 - 148)

### DESCRIPCIÓN

### REF.

### MEDIDAS

### LEVA

### ACABADOS

### UDS

B A

FRENTE CILINDRO

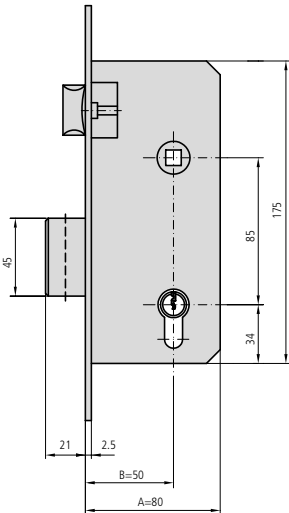
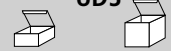

- Cerradura con resbalón y palanca
- Cilindro de leva larga 5982/2525
- Cerradero CE1985/2 o CE1985/6

1985N/40/2	40	68	15	HL	CL	1	12
1985N/40/6	40	68	15	AI	CN	1	12
1985N/50/2	50	78	15	HL	CL	1	12
1985N/50/6	50	78	15	AI	CN	1	12
1985N/60/2	60	88	15	HL	CL	1	12
1985N/60/6	60	88	15	AI	CN	1	12

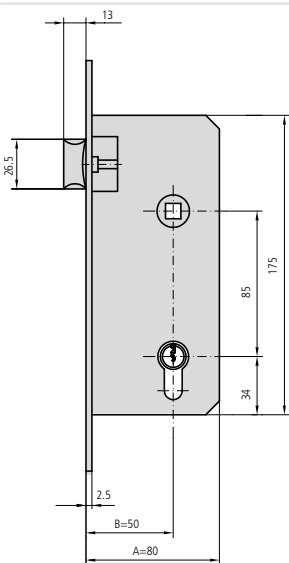

- Cerradura de sólo picaporte
- Con medio cilindro 5982T40
- Cerradero CE1970R/2 o CE1970R/6

1985NT40/2	40	68	15	HL	CL	1	12
1985NT40/6	40	68	15	AI	CN	1	12
1985NT50/2	50	78	15	HL	CL	1	12
1985NT50/6	50	78	15	AI	CN	1	12
1985NT60/2	60	88	15	HL	CL	1	12
1985NT60/6	60	88	15	AI	CN	1	12

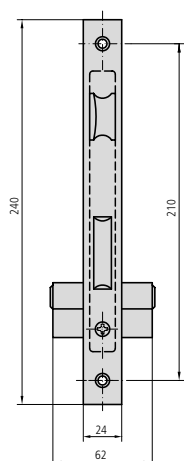

**CARACTERÍSTICAS**

- Entre ejes 70 mm
- Frente de hierro latonado o acero inoxidable
- Picaporte reversible accionable mediante llave y manilla
- Palanca deslizante a dos vueltas de llave
- Cerradero según cerradura
- Embellecedor ES1960
- Componentes de sujeción
- Cilindro europerfil

**ACCESORIOS OPCIONALES**

- Gama completa de cilindros (ver página 128 - 148)

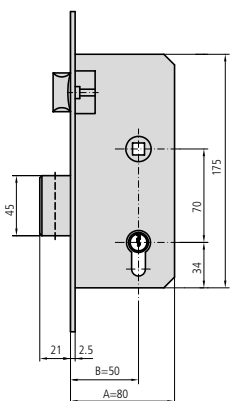
DESCRIPCIÓN	REF.	MEDIDAS		LEVA	ACABADOS		UDS	
		B	A		FRENTE	CILINDRO		



• Cerradura con picaporte y palanca	1970N/40/2	40	68	15	HL	CL	1	12
	1970N/40/6	40	68	15	AI	CN	1	12
• Cilindro de leva larga 5982/2525	1970N/50/2	50	78	15	HL	CL	1	12
	1970N/50/6	50	78	15	AI	CN	1	12
• Cerradero CE1985/2 o CE1985/6	1970N/60/2	60	88	15	HL	CL	1	12
	1970N/60/6	60	88	15	AI	CN	1	12

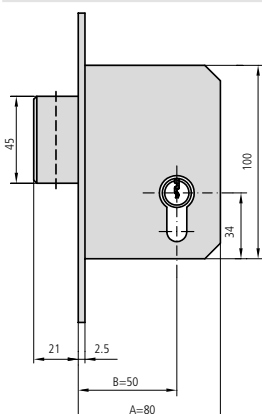

• Cerradura con sólo palanca	1970NA40/2	40	68	15	HL	CL	1	20
	1970NA40/6	40	68	15	AI	CN	1	20
• Cilindro de leva larga 5982/2525	1970NA50/2	50	78	15	HL	CL	1	20
	1970NA50/6	50	78	15	AI	CN	1	20
• Cerradero CE1970A/2 o CE1970A/6	1970NA60/2	60	88	15	HL	CL	1	20
	1970NA60/6	60	88	15	AI	CN	1	20

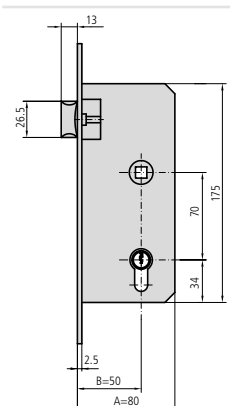

• Cerradura de sólo picaporte	1970NT40/2	40	68	15	HL	CL	1	12
	1970NT40/6	40	68	15	AI	CN	1	12
• Con medio cilindro 5982T40	1970NT50/2	50	78	15	HL	CL	1	12
	1970NT50/6	50	78	15	AI	CN	1	12
• Cerradero CE1970R/2 o CE1970R/6	1970NT60/2	60	88	15	HL	CL	1	12
	1970NT60/6	60	88	15	AI	CN	1	12

## CERRADURAS DE PALANCA RECTANGULAR DESLIZANTE

## SERIE 1970N

DESCRIPCIÓN	REF.	MEDIDAS		LEVA	ACABADOS		UDS	UDS
		B	A		FRENTE	CILINDRO		
<ul style="list-style-type: none"> <li>• Cerradura con rodillo y palanca</li> <li>• Con cilindro</li> <li>• Cerradero CE1985/2 o CE1985/6</li> </ul>	1970NV40/6	40	68	15	Al	CN	1	12
	1970NV50/6	50	78	15	Al	CN	1	12
	1970NV60/6	60	88	15	Al	CN	1	12

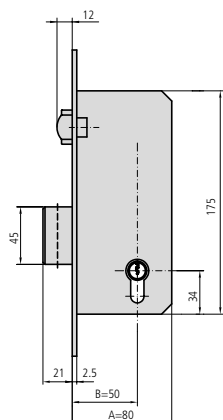

## CERRADURAS DE PALANCA RECTANGULAR DESLIZANTE

## SERIE 1960

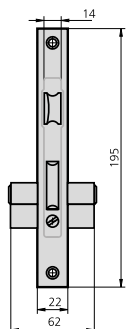

### CARACTERÍSTICAS

- Entre ejes 48 mm
- Frente de hierro latonado o acero inoxidable
- Picaporte reversible accionable mediante llave y manilla
- Palanca deslizante accionado por una vuelta de llave
- Cerradero según cerradura
- Embellecedor ES1960
- Componentes de sujeción
- Cilindro europerfil

### ACCESORIOS OPCIONALES

- Gama completa de cilindros (ver página 128 - 148)
- Kit para adaptación condensa (ver página 167)

DESCRIPCIÓN	REF.	MEDIDAS		LEVA	ACABADOS		UDS	
		B	A		FRENTE	CILINDRO		

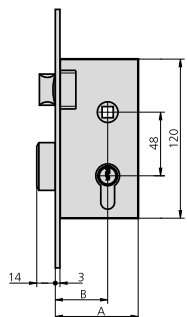

- Cerradura con picaporte y palanca
- Cilindro de leva larga 5982/2525
- Cerradero CE1960/2 o CE1960/6

1960/60/2	40	62	15	HL	CL	1	20
1960/60/6	40	62	15	AI	CN	1	20
1960/70/2	50	72	15	HL	CL	1	20
1960/70/6	50	72	15	AI	CN	1	20

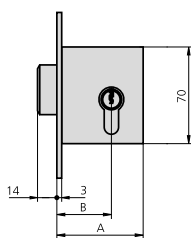

- Cerradura con sólo palanca
- Cilindro de leva larga 5982/2525
- Cerradero CE1960A/2 o CE1960A/6

1960A60/2	40	62	15	HL	CL	1	30
1960A60/6	40	62	15	AI	CN	1	30
1960A70/2	50	72	15	HL	CL	1	30
1960A70/6	50	72	15	AI	CN	1	30

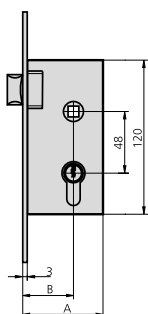

- Cerradura de sólo picaporte
- Con medio cilindro 5982T40
- Cerradero CE249R/2 o CE249R/6

1960T60/2	40	62	15	HL	CL	1	20
1960T60/6	40	62	15	AI	CN	1	20
1960T70/2	50	72	15	HL	CL	1	20
1960T70/6	50	72	15	AI	CN	1	20

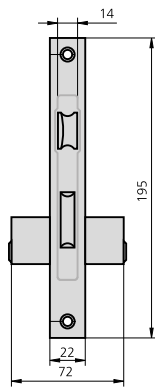

CARACTERÍSTICAS

- Frente de hierro latonado
- Picaporte reversible accionable mediante llave y manilla
- Palanca deslizante accionado por llave
- Cerradero según cerradura
- Embellecedor ES1964
- Componentes de sujeción

ACCESORIOS OPCIONALES

- Gama completa de cilindros (ver página 128 - 148)

DESCRIPCIÓN	REF.	MEDIDAS		LEVA	ACABADOS		UDS	
		B	A		FRENTE	CILINDRO		

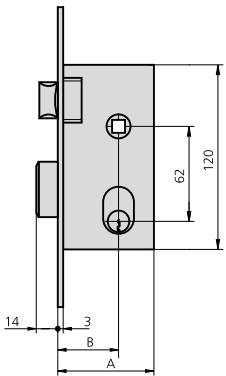

- Cerradura con picaporte y palanca
- Cerradero CE1960/2
- Cilindro ovalado 5961/2525/3

1961/60/2	40	62	HL	CL	1	20
1961/70/2	50	72	HL	CL	1	20

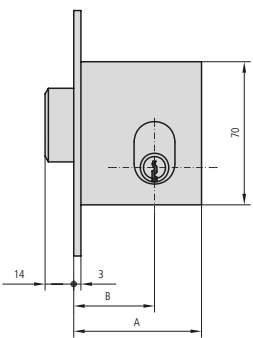

- Cerradura con sólo palanca
- Cerradero CE1960A/2
- Cilindro ovalado 5961/2525/3

1961A60/2	40	62	HL	CL	1	20
1961A70/2	50	72	HL	CL	1	20

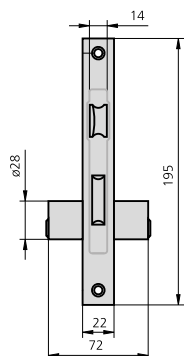
**CERRADURAS DE PALANCA RECTANGULAR DESLIZANTE**
**SERIE 1962**

**CARACTERÍSTICAS**

- Frente de hierro latonado
- Picaporte reversible accionable mediante llave y manilla
- Palanca deslizante accionado por llave
- Cerradero según cerradura
- Embellecedor ES1962
- Componentes de sujeción
- Cilindro redondo

**ACCESORIOS OPCIONALES**

- Gama completa de cilindros (ver página 128 - 148)

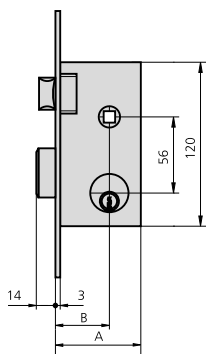
DESCRIPCIÓN	REF.	MEDIDAS		LEVA	ACABADOS		UDS	
		B	A		FRENTE	CILINDRO		



- Cerradura con picaporte y palanca
- Cilindro redondo 5962/2525/3
- Cerradero CE1960/2

1962/60/2	40	62	HL	CL	1	20
1962/70/2	50	72	HL	CL	1	20

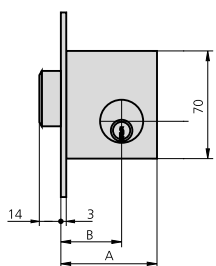

- Cerradura con sólo palanca
- Cilindro redondo 5962/2525/3
- Cerradero CE1960A/2

1962A60/2	40	62	HL	CL	1	30
1962A70/2	50	72	HL	CL	1	30

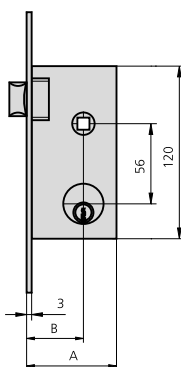

- Cerradura de sólo picaporte
- Medio cilindro redondo 5962T30/3
- Cerradero CE249R/2

1962T60/2	40	62	HL	CL	1	20
1962T70/2	50	72	HL	CL	1	20



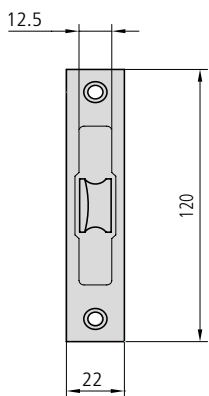

CARACTERÍSTICAS

- Frente de hierro latonado
- Picaporte reversible accionable mediante manilla
- Cerradero según cerradura
- Componentes de sujeción

ACCESORIOS OPCIONALES

DESCRIPCIÓN	REF.	MEDIDAS		LEVA	ACABADOS		UDS	
		B	A		FRENTE	CILINDRO		

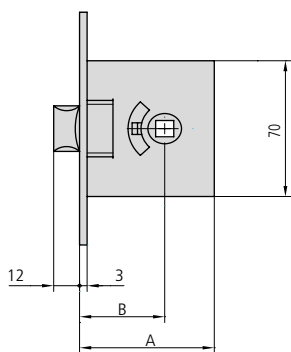

• Cerradura reversible	249B50/2	37	52	HL		1	20
• Picaporte accionable mediante manilla	249B60/2	44	62	HL		1	20
• Cerradero CE249R/2	249B70/2	50	72	HL		1	20

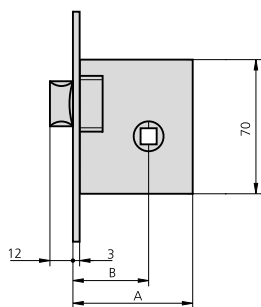

• Picaporte reversible accionable mediante manilla	249R50/2	30	52	HL		1	30
	249R60/2	40	62	HL		1	30
• Cerradero CE249R/2	249R70/2	50	72	HL		1	30

DESCRIPCIÓN	REF.	ACABADO	APLICABLE A CERRADURAS	UDS
-------------	------	---------	------------------------	-----

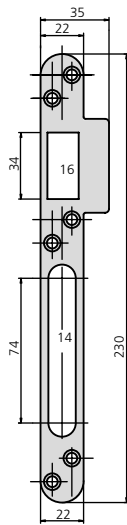

CE4000/2	HL	4000, 4010
CE4000/6	Al	

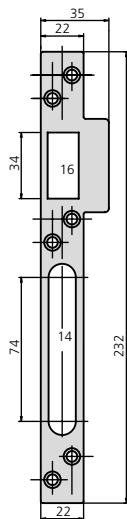

CE4001/2	HL	4001, 4011
CE4001/6	Al	

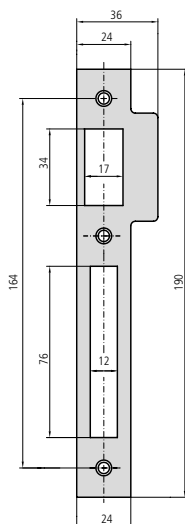

CE1985/2	HL	1970, 1970C, 1970V
CE1985/6	Al	1985, 1985C, 1985/3P

# ACCESORIOS

# CERRADEROS

DESCRIPCIÓN

REF.

ACABADO

APLICABLE A  
CERRADURAS

UDS

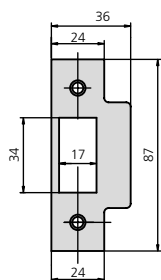

CE1970R/2 HL 1970T, 1985T  
CE1970R/6 AI

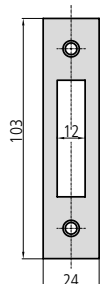

CE1970A/2 HL 1970A  
CE1970A/6 AI

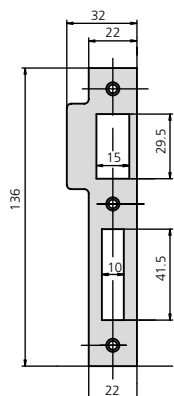

CE1960/2 HL 1960, 1961, 1962,  
CE1960/6 AI 249C, 63R

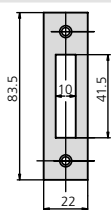

CE1960A/2 HL 1960A, 1961A,  
CE1960A/6 AI 1962A

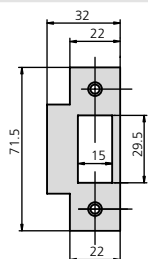

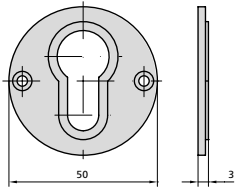
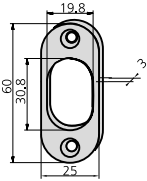

CE249R/2 HL 1960T, 1962T,  
CE249R/6 AI 249B, 249R

**ACCESORIOS**
**ESCUDOS**

DESCRIPCIÓN	REF.	ACABADO	APLICABLE A CERRADURAS	UDS  
	ES1960 ES1960/4	LP LN	1960, 1970, 1985, 156	
	ES1962 ES1962/4	LP LN	1962, 11981	
	ES1964	Escudo de nylon	1961	
	ES1985/0 ES1985/7	Niquelado Niquelado mate	1985, 1970, 1960	

**ACCESORIOS**
**ESCUDOS DE SEGURIDAD**

DESCRIPCIÓN	REF.	APLICABLE A CERRADURAS	UDS  
	KES4000	4000, 4001, 4010, 4011, 4100, 4110	
	KES4100	4000, 4001, 4010, 4011, 4100, 4110	

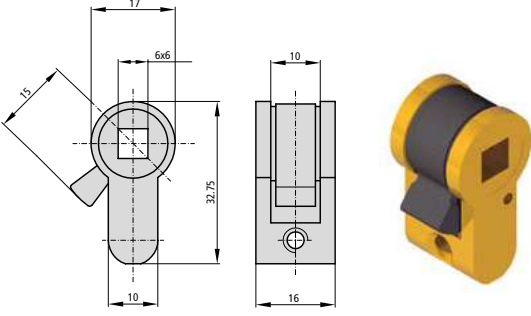
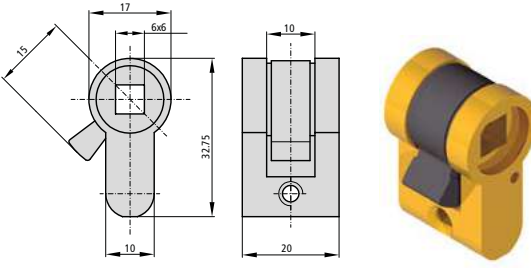
DESCRIPCIÓN	REF.	APLICABLE A CERRADURAS	UDS  
<ul style="list-style-type: none"> <li>Leva larga</li> </ul> 	5982C16	1960 (60-70)	
<ul style="list-style-type: none"> <li>Leva larga</li> </ul> 	5982C20	1985N (40-50-60) 1970N (40-50-60)	

## CILINDROS

	<b>Cilindro europerfil normal leva larga</b>	<b>126</b>
	• Serie 5982	126
	• Serie 582PM, 5982T, 5982PT	128
	<b>Cilindro europerfil normal leva corta</b>	<b>130</b>
	• Serie 5990	130
	• Serie 590PM, 5990T, 5990PT	132
	<b>Cilindro europerfil de seguridad leva larga</b>	<b>134</b>
	• Serie 6982	134
	• Serie 682PM, 6982T	135
	<b>Cilindro europerfil de seguridad leva corta</b>	<b>137</b>
	• Serie 6990	137
	• Serie 690PM, 6990T	137
	<b>Cilindros ovalados y redondos</b>	<b>140</b>
	• Serie 5963	140
	• Serie 5081	141
	• Serie 5961	142
• Serie 5962	143	
• Serie 5964	144	
• Serie 5968	145	
• Serie 5979	146	

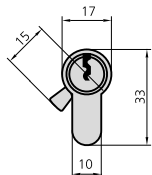





CARACTERÍSTICAS

- Cuerpo de latón
- Rotores de latón
- Leva larga de 15 mm
- 5 pitones
- 3 llaves

ACCESORIOS OPCIONALES

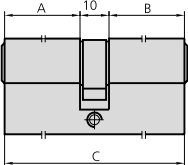

DESCRIPCIÓN	REF.	MEDIDAS			ACABADOS	UDS  
		A	B	C		
 <ul style="list-style-type: none"> <li>• Cilindro doble</li> </ul>	5982/2525/3	26	26	62	LP	1
	5982/2525/4	26	26	62	LN	1
	5982/2530/3	26	31	67	LP	1
	5982/2530/4	26	31	67	LN	1
	5982/2535/3	26	36	72	LP	1
	5982/2535/4	26	36	72	LN	1
	5982/3030/3	31	31	72	LP	1
	5982/3030/4	31	31	72	LN	1
	5982/2540/3	26	41	77	LP	1
	5982/2540/4	26	41	77	LN	1
	5982/3035/3	31	36	77	LP	1
	5982/3035/4	31	36	77	LN	1
	5982/2545/3	26	46	82	LP	1
	5982/2545/4	26	46	82	LN	1
	5982/3040/3	31	41	82	LP	1
	5982/3040/4	31	41	82	LN	1
	5982/3535/3	36	36	82	LP	1
	5982/3535/4	36	36	82	LN	1
	5982/2550/3	26	51	87	LP	1
	5982/2550/4	26	51	87	LN	1
	5982/3540/3	36	41	87	LP	1
	5982/3540/4	36	41	87	LN	1
	5982/3045/3	31	46	87	LP	1
	5982/3045/4	31	46	87	LN	1
	5982/2555/3	26	56	92	LP	1
	5982/2555/4	26	56	92	LN	1
	5982/3050/3	31	51	92	LP	1
	5982/3050/4	31	51	92	LN	1
5982/3545/3	36	46	92	LP	1	
5982/3545/4	36	46	92	LN	1	
5982/4040/3	41	41	92	LP	1	
5982/4040/4	41	41	92	LN	1	
5982/2560/3	26	61	97	LP	1	
5982/2560/4	26	61	97	LN	1	
5982/3055/3	31	56	97	LP	1	
5982/3055/4	31	56	97	LN	1	
5982/2565/3	26	66	102	LP	1	
5982/2565/4	26	66	102	LN	1	
5982/3060/3	31	61	102	LP	1	
5982/3060/4	31	61	102	LN	1	
5982/3555/3	36	56	102	LP	1	
5982/3555/4	36	56	102	LN	1	

DESCRIPCIÓN	REF.	MEDIDAS			ACABADOS	UDS  
		A	B	C		
	5982/4050/3	41	51	102	LP	1
	5982/4050/4	41	51	102	LN	1
	5982/4545/3	46	46	102	LP	1
	5982/4545/4	46	46	102	LN	1
	5982/4055/3	41	56	107	LP	1
	5982/4055/4	41	56	107	LN	1
	5982/2575/3	26	76	112	LP	1
	5982/2575/4	26	76	112	LN	1
	5982/3565/3	36	66	112	LP	1
	5982/3565/4	36	66	112	LN	1
	5982/4060/3	41	61	112	LP	1
	5982/4060/4	41	61	112	LN	1
	5982/4555/3	46	56	112	LP	1
	5982/4555/4	46	56	112	LN	1
	5982/5050/3	51	51	112	LP	1
	5982/5050/4	51	51	112	LN	1
	5982/2585/3	26	86	122	LP	1
	5982/2585/4	26	86	122	LN	1
	5982/3080/3	31	81	122	LP	1
	5982/3080/4	31	81	122	LN	1
	5982/3575/3	36	76	122	LP	1
	5982/3575/4	36	76	122	LN	1
	5982/4070/3	41	71	122	LP	1
	5982/4070/4	41	71	122	LN	1
	5982/5555/3	56	56	122	LP	1
	5982/5555/4	56	56	122	LN	1
	5982/2595/3	26	96	132	LP	1
	5982/2595/4	26	96	132	LN	1
	5982/4080/3	41	81	132	LP	1
	5982/4080/4	41	81	132	LN	1
	5982/6060/3	61	61	132	LP	1
	5982/6060/4	61	61	132	LN	1
	5982/3595/3	36	96	142	LP	1
	5982/3595/4	36	96	142	LN	1
	5982/6565/3	66	66	142	LP	1
	5982/6565/4	66	66	142	LN	1
	5982/7070/3	71	71	152	LP	1
	5982/7070/4	71	71	152	LN	1
	5982/7575/3	76	76	162	LP	1
	5982/7575/4	76	76	162	LN	1



DESCRIPCIÓN

REF.

MEDIDAS

ACABADOS

UDS

A B C



• Cilindro con pomo

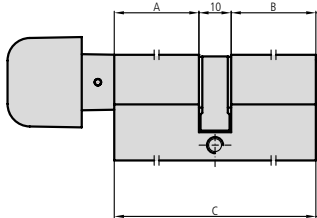

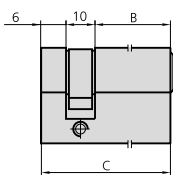

582PM2525/3	26	26	62	LP	1
582PM2525/4	26	26	62	LN	1
582PM2530/3	26	31	67	LP	1
582PM2530/4	26	31	67	LN	1
582PM2535/3	26	36	72	LP	1
582PM2535/4	26	36	72	LN	1
582PM3030/3	31	31	72	LP	1
582PM3030/4	31	31	72	LN	1
582PM3525/3	36	26	72	LP	1
582PM3525/4	36	26	72	LN	1
582PM2540/3	26	41	77	LP	1
582PM2540/4	26	41	77	LN	1
582PM2545/3	26	46	82	LP	1
582PM2545/4	26	46	82	LN	1
582PM3535/3	36	36	82	LP	1
582PM3535/4	36	36	82	LN	1
582PM2550/3	26	51	87	LP	1
582PM2550/4	26	51	87	LN	1
582PM3045/3	31	46	87	LP	1
582PM3045/4	31	46	87	LN	1
582PM3540/3	36	41	87	LP	1
582PM3540/4	36	41	87	LN	1
582PM2555/3	26	56	92	LP	1
582PM2555/4	26	56	92	LN	1
582PM3545/3	36	46	92	LP	1
582PM3545/4	36	46	92	LN	1
582PM2560/3	26	61	97	LP	1
582PM2560/4	26	61	97	LN	1
582PM2565/3	26	66	102	LP	1
582PM2565/4	26	66	102	LN	1

• Medio cilindro

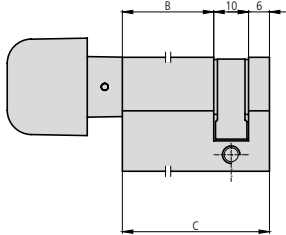
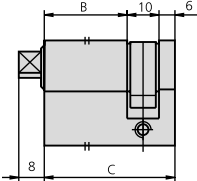
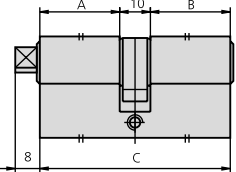
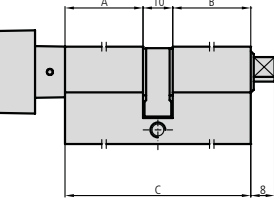

5982T40/3	26	42	LP	1
5982T40/4	26	42	LN	1
5982T45/3	31	47	LP	1
5982T45/4	31	47	LN	1
5982T50/3	36	52	LP	1
5982T50/4	36	52	LN	1
5982T55/3	41	57	LP	1
5982T55/4	41	57	LN	1
5982T60/3	46	62	LP	1
5982T60/4	46	62	LN	1
5982T65/3	51	67	LP	1
5982T65/4	51	67	LN	1
5982T70/3	56	72	LP	1
5982T70/4	56	72	LN	1

DESCRIPCIÓN	REF.	MEDIDAS			ACABADOS	UDS  
		A	B	C		
<ul style="list-style-type: none"> <li>Medio cilindro con pomo</li> </ul> 	582PM2505/3		26	42	LP	1
	582PM2505/4		26	42	LN	1
	582PM3005/3		31	47	LP	1
	582PM3005/4		31	47	LN	1
	582PM3505/3		36	52	LP	1
	582PM3505/4		36	52	LN	1
	582PM4005/3		41	57	LP	1
	582PM4005/4		41	57	LN	1
	582PM4505/3		46	62	LP	1
	582PM4505/4		46	62	LN	1
	582PM5005/3		51	67	LP	1
	582PM5005/4		51	67	LN	1
	582PM5505/3		56	72	LP	1
	582PM5505/4		56	72	LN	1
<ul style="list-style-type: none"> <li>Medio cilindro</li> <li>Triángulo por un lado</li> </ul> 	5982PT2505/3		26	42	LP	1
	5982PT2505/4		26	42	LN	1
<ul style="list-style-type: none"> <li>Doble cilindro</li> <li>Llave por un lado y triángulo por el otro</li> </ul> 	5982PT2525/3	26	26	62	LP	1
	5982PT2525/4	26	26	62	LN	1
	5982PT2535/3	26	36	72	LP	1
	5982PT2535/4	26	36	72	LN	1
	5982PT2545/3	26	46	82	LP	1
	5982PT2545/4	26	46	82	LN	1
<ul style="list-style-type: none"> <li>Doble cilindro</li> <li>Triángulo por un lado y pomo por el otro</li> </ul> 	582PM25T25/3	26	26	62	LP	1
	582PM25T25/4	26	26	62	LN	1
	582PM30T30/3	31	31	72	LP	1
	582PM30T30/4	31	31	72	LN	1
	582PM35T25/3	36	26	72	LP	1
	582PM35T25/4	36	26	72	LN	1
	582PM35T35/3	36	36	82	LP	1
	582PM35T35/4	36	36	82	LN	1
	582PM30T45/3	31	46	87	LP	1
	582PM30T45/4	31	46	87	LN	1



CARACTERÍSTICAS

- Cuerpo de latón
- Rotores de latón
- Leva corta de 13,25 mm
- 5 pitones
- 3 llaves

ACCESORIOS OPCIONALES

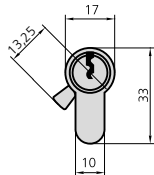

DESCRIPCIÓN

REF.

MEDIDAS

ACABADOS



UDS

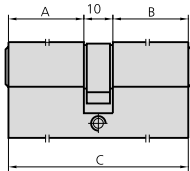
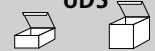

A B C



• Cilindro doble

5990/2525/3	26	26	62	LP	1
5990/2525/4	26	26	62	LN	1
5990/2530/3	26	31	67	LP	1
5990/2530/4	26	31	67	LN	1
5990/2535/3	26	36	72	LP	1
5990/2535/4	26	36	72	LN	1
5990/3030/3	31	31	72	LP	1
5990/3030/4	31	31	72	LN	1
5990/2540/3	26	41	77	LP	1
5990/2540/4	26	41	77	LN	1
5990/3035/3	31	36	77	LP	1
5990/3035/4	31	36	77	LN	1
5990/2545/3	26	46	82	LP	1
5990/2545/4	26	46	82	LN	1
5990/3040/3	31	41	82	LP	1
5990/3040/4	31	41	82	LN	1
5990/3535/3	36	36	82	LP	1
5990/3535/4	36	36	82	LN	1
5990/2550/3	26	51	87	LP	1
5990/2550/4	26	51	87	LN	1
5990/3540/3	36	41	87	LP	1
5990/3540/4	36	41	87	LN	1
5990/3045/3	31	46	87	LP	1
5990/3045/4	31	46	87	LN	1
5990/2555/3	26	56	92	LP	1
5990/2555/4	26	56	92	LN	1
5990/3050/3	31	51	92	LP	1
5990/3050/4	31	51	92	LN	1
5990/3545/3	36	46	92	LP	1
5990/3545/4	36	46	92	LN	1
5990/4040/3	41	41	92	LP	1
5990/4040/4	41	41	92	LN	1
5990/2560/3	26	61	97	LP	1
5990/2560/4	26	61	97	LN	1
5990/3055/3	31	56	97	LP	1
5990/3055/4	31	56	97	LN	1
5990/2565/3	26	66	102	LP	1
5990/2565/4	26	66	102	LN	1

DESCRIPCIÓN	REF.	MEDIDAS			ACABADOS	UDS  
		A	B	C		
	5990/3060/3	31	61	102	LP	1
	5990/3060/4	31	61	102	LN	1
	5990/3555/3	36	56	102	LP	1
	5990/3555/4	36	56	102	LN	1
	5990/4050/3	41	51	102	LP	1
	5990/4050/4	41	51	102	LN	1
	5990/4545/3	46	46	102	LP	1
	5990/4545/4	46	46	102	LN	1
	5990/4055/3	41	56	107	LP	1
	5990/4055/4	41	56	107	LN	1
	5990/2575/3	26	76	112	LP	1
	5990/2575/4	26	76	112	LN	1
	5990/3565/3	36	66	112	LP	1
	5990/3565/4	36	66	112	LN	1
	5990/4060/3	41	61	112	LP	1
	5990/4060/4	41	61	112	LN	1
	5990/4555/3	46	56	112	LP	1
	5990/4555/4	46	56	112	LN	1
	5990/5050/3	51	51	112	LP	1
	5990/5050/4	51	51	112	LN	1
	5990/2585/3	26	86	122	LP	1
	5990/2585/4	26	86	122	LN	1
	5990/3080/3	31	81	122	LP	1
	5990/3080/4	31	81	122	LN	1
	5990/3575/3	36	76	122	LP	1
	5990/3575/4	36	76	122	LN	1
	5990/4070/3	41	71	122	LP	1
	5990/4070/4	41	71	122	LN	1
	5990/5555/3	56	56	122	LP	1
	5990/5555/4	56	56	122	LN	1
	5990/2595/3	26	96	132	LP	1
	5990/2595/4	26	96	132	LN	1
	5990/4080/3	41	81	132	LP	1
	5990/4080/4	41	81	132	LN	1
	5990/6060/3	61	61	132	LP	1
	5990/6060/4	61	61	132	LN	1
	5990/3595/3	36	96	142	LP	1
	5990/3595/4	36	96	142	LN	1
	5990/6565/3	66	66	142	LP	1
	5990/6565/4	66	66	142	LN	1
	5990/7070/3	71	71	152	LP	1
	5990/7070/4	71	71	152	LN	1
	5990/7575/3	76	76	162	LP	1
	5990/7575/4	76	76	162	LN	1

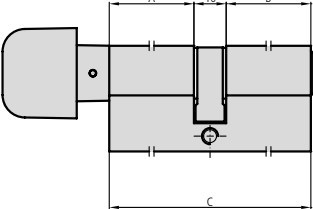
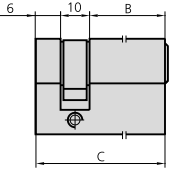
DESCRIPCIÓN	REF.	MEDIDAS			ACABADOS	UDS  
		A	B	C		
 <ul style="list-style-type: none"> <li>Cilindro con pomo</li> </ul>	590PM2525/3	26	26	62	LP	1
	590PM2525/4	26	26	62	LN	1
	590PM2530/3	26	31	67	LP	1
	590PM2530/4	26	31	67	LN	1
	590PM2535/3	26	36	72	LP	1
	590PM2535/4	26	36	72	LN	1
	590PM3030/3	31	31	72	LP	1
	590PM3030/4	31	31	72	LN	1
	590PM3525/3	36	26	72	LP	1
	590PM3525/4	36	26	72	LN	1
	590PM2540/3	26	41	77	LP	1
	590PM2540/4	26	41	77	LN	1
	590PM2545/3	26	46	82	LP	1
	590PM2545/4	26	46	82	LN	1
	590PM3535/3	36	36	82	LP	1
	590PM3535/4	36	36	82	LN	1
	590PM2550/3	26	51	87	LP	1
	590PM2550/4	26	51	87	LN	1
	590PM3045/3	31	46	87	LP	1
	590PM3045/4	31	46	87	LN	1
	590PM3540/3	36	41	87	LP	1
	590PM3540/4	36	41	87	LN	1
	590PM2555/3	26	56	92	LP	1
	590PM2555/4	26	56	92	LN	1
	590PM3545/3	36	46	92	LP	1
	590PM3545/4	36	46	92	LN	1
	590PM2560/3	26	61	97	LP	1
	590PM2560/4	26	61	97	LN	1
	590PM2565/3	26	66	102	LP	1
	590PM2565/4	26	66	102	LN	1
 <ul style="list-style-type: none"> <li>Medio cilindro</li> </ul>	5990T40/3	26	42	LP	1	
	5990T40/4	26	42	LN	1	
	5990T45/3	31	47	LP	1	
	5990T45/4	31	47	LN	1	
	5990T50/3	36	52	LP	1	
	5990T50/4	36	52	LN	1	
	5990T55/3	41	57	LP	1	
	5990T55/4	41	57	LN	1	
	5990T60/3	46	62	LP	1	
	5990T60/4	46	62	LN	1	
	5990T65/3	51	67	LP	1	
	5990T65/4	51	67	LN	1	
	5990T70/3	56	72	LP	1	
	5990T70/4	56	72	LN	1	

**CILINDRO EUROPERFIL NORMAL LEVA CORTA**
**SERIE 590PM, 5990PT**

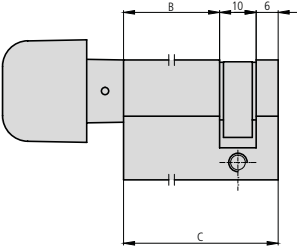
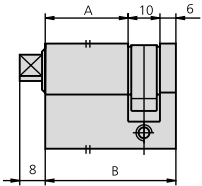
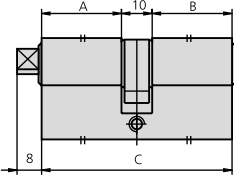
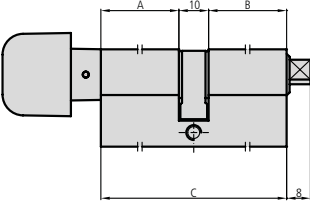
DESCRIPCIÓN	REF.	MEDIDAS			ACABADOS	UDS
		A	B	C		
 <ul style="list-style-type: none"> <li>Medio cilindro con pomo</li> </ul>	590PM2505/3	26	42	LP	1	
	590PM2505/4	26	42	LN	1	
	590PM3005/3	31	47	LP	1	
	590PM3005/4	31	47	LN	1	
	590PM3505/3	36	52	LP	1	
	590PM3505/4	36	52	LN	1	
	590PM4005/3	41	57	LP	1	
	590PM4005/4	41	57	LN	1	
	590PM4505/3	46	62	LP	1	
	590PM4505/4	46	62	LN	1	
	590PM5005/3	51	67	LP	1	
	590PM5005/4	51	67	LN	1	
	590PM5505/3	56	72	LP	1	
	590PM5505/4	56	72	LN	1	
 <ul style="list-style-type: none"> <li>Medio cilindro</li> <li>Triángulo por un lado</li> </ul>	5990PT2505/3	26	42	LP	1	
	5990PT2505/4	26	42	LN	1	
 <ul style="list-style-type: none"> <li>Doble cilindro</li> <li>Llave por un lado y triángulo por el otro</li> </ul>	5990PT2525/3	26	26	62	LP	1
	5990PT2525/4	26	26	62	LN	1
	5990PT2535/3	26	36	72	LP	1
	5990PT2535/4	26	36	72	LN	1
	5990PT2545/3	26	46	82	LP	1
	5990PT2545/4	26	46	82	LN	1
 <ul style="list-style-type: none"> <li>Doble cilindro</li> <li>Triángulo por un lado y pomo por el otro</li> </ul>	590PM25T25/3	26	26	62	LP	1
	590PM25T25/4	26	26	62	LN	1
	590PM30T30/3	31	31	72	LP	1
	590PM30T30/4	31	31	72	LN	1
	590PM35T25/3	36	26	72	LP	1
	590PM35T25/4	36	26	72	LN	1
	590PM35T35/3	36	36	82	LP	1
	590PM35T35/4	36	36	82	LN	1
	590PM30T45/3	31	46	87	LP	1
	590PM30T45/4	31	46	87	LN	1



CARACTERÍSTICAS

- Cuerpo de latón
- Rotores de latón
- Leva larga de 15 mm
- Pasadores antitaladro
- 5 pitones de inoxidable
- 5 llaves

ACCESORIOS OPCIONALES

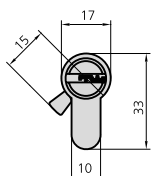

DESCRIPCIÓN

REF.

MEDIDAS

ACABADOS

UDS

A B C

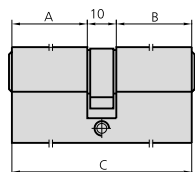



- Cilindro doble

6982/2525/3	26	26	62	LP	1
6982/2525/4	26	26	62	LN	1
6982/2530/3	26	31	67	LP	1
6982/2530/4	26	31	67	LN	1
6982/2535/3	26	36	72	LP	1
6982/2535/4	26	36	72	LN	1
6982/3030/3	31	31	72	LP	1
6982/3030/4	31	31	72	LN	1
6982/2540/3	26	41	77	LP	1
6982/2540/4	26	41	77	LN	1
6982/3035/3	31	36	77	LP	1
6982/3035/4	31	36	77	LN	1
6982/2545/3	26	46	82	LP	1
6982/2545/4	26	46	82	LN	1
6982/3040/3	31	41	82	LP	1
6982/3040/4	31	41	82	LN	1
6982/3535/3	36	36	82	LP	1
6982/3535/4	36	36	82	LN	1
6982/2550/3	26	51	87	LP	1
6982/2550/4	26	51	87	LN	1
6982/3540/3	36	41	87	LP	1
6982/3540/4	36	41	87	LN	1
6982/3045/3	31	46	87	LP	1
6982/3045/4	31	46	87	LN	1
6982/2555/3	26	56	92	LP	1
6982/2555/4	26	56	92	LN	1
6982/3050/3	31	51	92	LP	1
6982/3050/4	31	51	92	LN	1
6982/3545/3	36	46	92	LP	1
6982/3545/4	36	46	92	LN	1
6982/4040/3	41	41	92	LP	1
6982/4040/4	41	41	92	LN	1
6982/2560/3	26	61	97	LP	1
6982/2560/4	26	61	97	LN	1
6982/3055/3	31	56	97	LP	1
6982/3055/4	31	56	97	LN	1
6982/4045/3	41	46	97	LP	1
6982/4045/4	41	46	97	LN	1

DESCRIPCIÓN	REF.	MEDIDAS			ACABADOS	UDS 
		A	B	C		
	6982/2565/3	26	66	102	LP	1
	6982/2565/4	26	66	102	LN	1
	6982/3060/3	31	61	102	LP	1
	6982/3060/4	31	61	102	LN	1
	6982/3555/3	36	56	102	LP	1
	6982/3555/4	36	56	102	LN	1
	6982/4050/3	41	51	102	LP	1
	6982/4050/4	41	51	102	LN	1
	6982/4545/3	46	46	102	LP	1
	6982/4545/4	46	46	102	LN	1
	6982/4055/3	41	56	107	LP	1
	6982/4055/4	41	56	107	LN	1
	6982/2575/3	26	76	112	LP	1
	6982/2575/4	26	76	112	LN	1
	6982/3565/3	36	66	112	LP	1
	6982/3565/4	36	66	112	LN	1
	6982/4555/3	46	56	112	LP	1
	6982/4555/4	46	56	112	LN	1
	6982/5050/3	51	51	112	LP	1
	6982/5050/4	51	51	112	LN	1
	6982/4560/3	46	61	117	LP	1
	6982/4560/4	46	61	117	LN	1
	6982/2585/3	26	86	122	LP	1
	6982/2585/4	26	86	122	LN	1
	6982/5555/3	56	56	122	LP	1
	6982/5555/4	56	56	122	LN	1
	6982/2595/3	26	96	132	LP	1
	6982/2595/4	26	96	132	LN	1
	6982/6565/3	66	66	142	LP	1
	6982/6565/4	66	66	142	LN	1
	6982/7070/3	71	71	152	LP	1
	6982/7070/4	71	71	152	LN	1
	6982/7575/3	76	76	162	LP	1
	6982/7575/4	76	76	162	LN	1



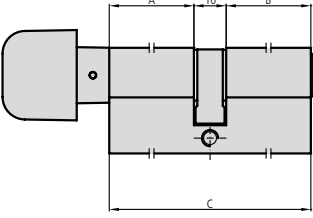

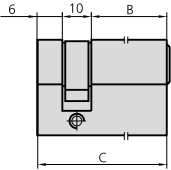
DESCRIPCIÓN	REF.	MEDIDAS			ACABADOS	UDS  
		A	B	C		
 <ul style="list-style-type: none"> <li>• Cilindro con pomo</li> </ul>	682PM2525/3	26	26	62	LP	1
	682PM2525/4	26	26	62	LN	1
	682PM2535/3	26	36	72	LP	1
	682PM2535/4	26	36	72	LN	1
	682PM3525/3	36	26	72	LP	1
	682PM3525/4	36	26	72	LN	1
	682PM3030/3	31	31	72	LP	1
	682PM3030/4	31	31	72	LN	1
	682PM2545/3	26	46	82	LP	1
	682PM2545/4	26	46	82	LN	1
	682PM3535/3	36	36	82	LP	1
	682PM3535/4	36	36	82	LN	1
	682PM2555/3	26	56	92	LP	1
	682PM2555/4	26	56	92	LN	1
	682PM3545/3	36	46	92	LP	1
	682PM3545/4	36	46	92	LN	1
	682PM3555/3	36	56	102	LP	1
	682PM3555/4	36	56	102	LN	1
	682PM3565/3	36	66	112	LP	1
	682PM3565/4	36	66	112	LN	1



 <ul style="list-style-type: none"> <li>• Medio cilindro</li> </ul>	6982T40/3	26	42	LP	1
	6982T40/4	26	42	LN	1
	6982T50/3	36	52	LP	1
	6982T50/4	36	52	LN	1
	6982T60/3	46	62	LP	1
	6982T60/4	46	62	LN	1
	6982T70/3	56	72	LP	1
	6982T70/4	56	72	LN	1

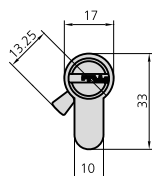

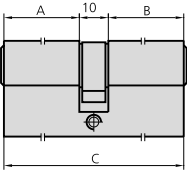

**CARACTERÍSTICAS**

- Cuerpo de latón
- Rotores de latón
- Leva corta de 13,25 mm
- Pasadores antitaladro
- 5 pitones de inoxidable
- 5 llaves

**ACCESORIOS OPCIONALES**

DESCRIPCIÓN	REF.	MEDIDAS			ACABADOS	UDS  
		A	B	C		
 <ul style="list-style-type: none"> <li>• Cilindro doble</li> </ul>	6990/2525/3	26	26	62	LP	1
	6990/2525/4	26	26	62	LN	1
	6990/2530/3	26	31	67	LP	1
	6990/2530/4	26	31	67	LN	1
	6990/2535/3	26	36	72	LP	1
	6990/2535/4	26	36	72	LN	1
	6990/3030/3	31	31	72	LP	1
	6990/3030/4	31	31	72	LN	1
	6990/2540/3	26	41	77	LP	1
	6990/2540/4	26	41	77	LN	1
	6990/3035/3	31	36	77	LP	1
	6990/3035/4	31	36	77	LN	1
	6990/2545/3	26	46	82	LP	1
	6990/2545/4	26	46	82	LN	1
	6990/3040/3	31	41	82	LP	1
	6990/3040/4	31	41	82	LN	1
	6990/3535/3	36	36	82	LP	1
	6990/3535/4	36	36	82	LN	1
	6990/2550/3	26	51	87	LP	1
	6990/2550/4	26	51	87	LN	1
	6990/3540/3	36	41	87	LP	1
	6990/3540/4	36	41	87	LN	1
	6990/3045/3	31	46	87	LP	1
	6990/3045/4	31	46	87	LN	1
	6990/2555/3	26	56	92	LP	1
	6990/2555/4	26	56	92	LN	1
	6990/3050/3	31	51	92	LP	1
	6990/3050/4	31	51	92	LN	1
	6990/3545/3	36	46	92	LP	1
	6990/3545/4	36	46	92	LN	1
	6990/4040/3	41	41	92	LP	1
	6990/4040/4	41	41	92	LN	1
	6990/2560/3	26	61	97	LP	1
	6990/2560/4	26	61	97	LN	1
	6990/3055/3	31	56	97	LP	1
	6990/3055/4	31	56	97	LN	1
	6990/4045/3	41	46	97	LP	1
	6990/4045/4	41	46	97	LN	1

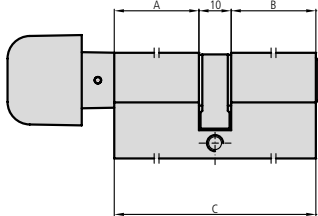
DESCRIPCIÓN	REF.	MEDIDAS			ACABADOS	UDS  
		A	B	C		
	6990/2565/3	26	66	102	LP	1
	6990/2565/4	26	66	102	LN	1
	6990/3060/3	31	61	102	LP	1
	6990/3060/4	31	61	102	LN	1
	6990/3555/3	36	56	102	LP	1
	6990/3555/4	36	56	102	LN	1
	6990/4050/3	41	51	102	LP	1
	6990/4050/4	41	51	102	LN	1
	6990/4545/3	46	46	102	LP	1
	6990/4545/4	46	46	102	LN	1
	6990/4055/3	41	56	107	LP	1
	6990/4055/4	41	56	107	LN	1
	6990/2575/3	26	76	112	LP	1
	6990/2575/4	26	76	112	LN	1
	6990/3565/3	36	66	112	LP	1
	6990/3565/4	36	66	112	LN	1
	6990/4555/3	46	56	112	LP	1
	6990/4555/4	46	56	112	LN	1
	6990/5050/3	51	51	112	LP	1
	6990/5050/4	51	51	112	LN	1
	6990/4560/3	46	61	117	LP	1
	6990/4560/4	46	61	117	LN	1
	6990/2585/3	26	86	122	LP	1
	6990/2585/4	26	86	122	LN	1
	6990/5555/3	56	56	122	LP	1
	6990/5555/4	56	56	122	LN	1
	6990/2595/3	26	96	132	LP	1
	6990/2595/4	26	96	132	LN	1
	6990/6565/3	66	66	142	LP	1
	6990/6565/4	66	66	142	LN	1
	6990/7070/3	71	71	152	LP	1
	6990/7070/4	71	71	152	LN	1
	6990/7575/3	76	76	162	LP	1
	6990/7575/4	76	76	162	LN	1

DESCRIPCIÓN	REF.	MEDIDAS			ACABADOS	UDS  
		A	B	C		
<ul style="list-style-type: none"> <li>• Cilindro con pomo</li> </ul> 	690PM2525/3	26	26	62	LP	1
	690PM2525/4	26	26	62	LN	1
	690PM2535/3	26	36	72	LP	1
	690PM2535/4	26	36	72	LN	1
	690PM3525/3	36	26	72	LP	1
	690PM3525/4	36	26	72	LN	1
	690PM3030/3	31	31	72	LP	1
	690PM3030/4	31	31	72	LN	1
	690PM2545/3	26	46	82	LP	1
	690PM2545/4	26	46	82	LN	1
	690PM3535/3	36	36	82	LP	1
	690PM3535/4	36	36	82	LN	1
	690PM2555/3	26	56	92	LP	1
	690PM2555/4	26	56	92	LN	1
	690PM3545/3	36	46	92	LP	1
	690PM3545/4	36	46	92	LN	1
	690PM3555/3	36	56	102	LP	1
	690PM3555/4	36	56	102	LN	1
	690PM3565/3	36	66	112	LP	1
	690PM3565/4	36	66	112	LN	1

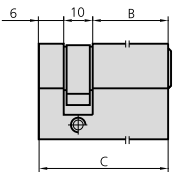

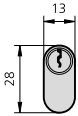
<ul style="list-style-type: none"> <li>• Medio cilindro</li> </ul> 	6990T40/3	26	42	LP	1
	6990T40/4	26	42	LN	1
	6990T50/3	36	52	LP	1
	6990T50/4	36	52	LN	1
	6990T60/3	46	62	LP	1
	6990T60/4	46	62	LN	1
	6990T70/3	56	72	LP	1
	6990T70/4	56	72	LN	1



CARACTERÍSTICAS

- Cilindro ovalado pequeño
- Cuerpo de latón
- Rotores de latón
- Dos levas
- 3 llaves

ACCESORIOS OPCIONALES

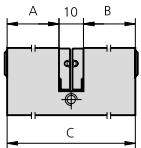
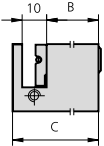
DESCRIPCIÓN	REF.	MEDIDAS			ACABADOS	APLICABLE A CERRADURAS	UDS	
		A	B	C				
 <ul style="list-style-type: none"> <li>• Cilindro doble</li> </ul>	5963/2222/3	22	22	54	LP		1	
	5963/2222/4	22	22	54	LN		1	
	5963/2525/3	26	26	62	LP		1	
	5963/2525/4	26	26	62	LN		1	
	5963/3030/3	31	31	72	LP	1963	1	
	5963/3030/4	31	31	72	LN	1975	1	
	5963/3535/3	36	36	82	LP		1	
	5963/3535/4	36	36	82	LN		1	
	5963/4040/3	41	41	92	LP		1	
	5963/4040/4	41	41	92	LN		1	
 <ul style="list-style-type: none"> <li>• Medio cilindro</li> </ul>	5963T36/3		22	36	LP	1963	1	
	5963T36/4		22	36	LN	1975	1	

**CARACTERÍSTICAS**

- Cuerpo de latón
- Rotores de latón
- Con levas y vástagos
- 3 llaves

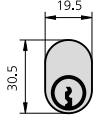
**ACCESORIOS OPCIONALES**

DESCRIPCIÓN	REF.	MEDIDAS			ACABADOS	APLICABLE A CERRADURAS	UDS	
		A	B	C				
 <ul style="list-style-type: none"> <li>• Cilindro doble</li> <li>• Ovalado</li> </ul>	5081/3030/3	26,5	26,5	74	LP		1	
	5081/3030/4	26,5	26,5	74	LN	1981	1	
 <ul style="list-style-type: none"> <li>• Cilindro doble</li> <li>• Redondo</li> </ul>	5181/3030/3	26,5	26,5	74	LP		1	
	5181/3030/4	26,5	26,5	74	LN	11981	1	



CARACTERÍSTICAS

- Cuerpo de latón
- Rotores de latón
- Con levas y vástagos
- 3 llaves

ACCESORIOS OPCIONALES

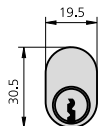

DESCRIPCIÓN

REF.

MEDIDAS

ACABADOS

APLICABLE A CERRADURAS

UDS



A B C

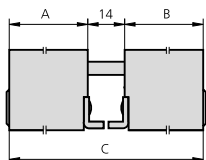

- Cilindro doble
- Ovalado

5961/2525/3	25	25	64	LP		1
5961/2525/4	25	25	64	LN		1
5961/3030/3	30	30	74	LP	1961	1
5961/3030/4	30	30	74	LN		1

**CARACTERÍSTICAS**

- Cuerpo de latón
- Rotores de latón
- Con levas y vástagos
- 3 llaves

**ACCESORIOS OPCIONALES**

DESCRIPCIÓN	REF.	MEDIDAS			ACABADOS	APLICABLE A CERRADURAS	UDS	
		A	B	C				
<ul style="list-style-type: none"> <li>• Cilindro doble</li> <li>• Redondo</li> </ul>	5962/2525/3	25	25	64	LP		1	
	5962/3030/3	30	30	74	LN	1962	1	
	5962/4040/3	40	40	94	LP		1	
<ul style="list-style-type: none"> <li>• Medio cilindro</li> <li>• Redondo</li> </ul>	5962T30/3			30	LP		1	
	5962T40/3			40	LN	1962	1	







CARACTERÍSTICAS

- Cilindro ovalado
- Cuerpo de latón
- Rotores de latón
- Con levas y vástagos
- 3 llaves

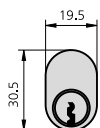
ACCESORIOS OPCIONALES

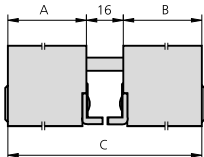
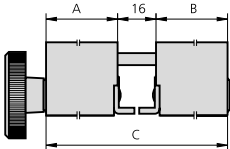
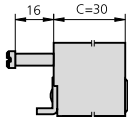
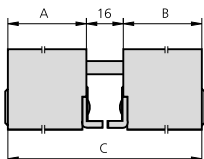
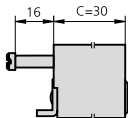

DESCRIPCIÓN	REF.	MEDIDAS			ACABADOS	APLICABLE A CERRADURAS	UDS	
		A	B	C				
 <ul style="list-style-type: none"> <li>• Cilindro doble</li> <li>• Llave normal</li> </ul>	5964/2525/3	25	25	66	LP	1964		1
	5964/2525/4	25	25	66	LN			1
	5964/3030/3	30	30	76	LP			1
	5964/3030/4	30	30	76	LN			1
	5964/4040/3	40	40	96	LP			1
	5964/4040/4	40	40	96	LN			1
 <ul style="list-style-type: none"> <li>• Cilindro doble con pomo</li> <li>• Llave normal</li> </ul>	5964P3030/3	30	30	76	LP	1964		1
	5964P3030/4	30	30	76	LN			1
 <ul style="list-style-type: none"> <li>• Medio cilindro</li> <li>• Llave normal</li> </ul>	5964T25/3			25	LP	1964		1
	5964T25/4			25	LN			1
	5964T30/3			30	LP			1
	5964T30/4			30	LN			1
	5964T40/3			40	LP			1
	5964T40/4			40	LN			1
 <ul style="list-style-type: none"> <li>• Cilindro doble</li> <li>• Llave de seguridad</li> </ul>	6964/3030/3	30	30	76	LP	1964		1
	6964/3030/4	30	30	76	LN			1
 <ul style="list-style-type: none"> <li>• Medio cilindro</li> <li>• Llave de seguridad</li> </ul>	6964T30/3			30	LP	1964		1
	6964T30/4			30	LN			1

CILINDROS

**CARACTERÍSTICAS**

- Cilindro ovalado
  - Cuerpo de latón
  - Rotores de latón
  - Con levas y vástagos
- 
- 3 llaves

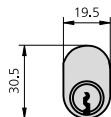
**ACCESORIOS OPCIONALES**

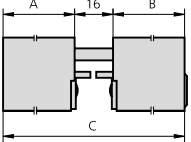
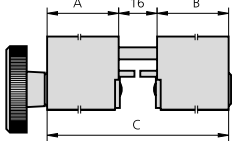
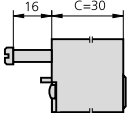
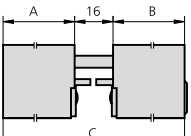
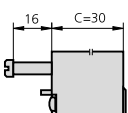
DESCRIPCIÓN	REF.	MEDIDAS			ACABADOS	APLICABLE A CERRADURAS	UDS	
		A	B	C				
 <ul style="list-style-type: none"> <li>• Cilindro doble</li> <li>• Llave normal</li> </ul>	5968/2525/3	25	25	66	LP	1968		1
	5968/2525/4	25	25	66	LN			1
	5968/3030/3	30	30	76	LP			1
	5968/3030/4	30	30	76	LN			1
	5968/4040/3	40	40	96	LP			1
	5968/4040/4	40	40	96	LN			1
 <ul style="list-style-type: none"> <li>• Cilindro doble con pomo</li> <li>• Llave normal</li> </ul>	5968P3030/3	30	30	76	LP	1968		1
	5968P3030/4	30	30	76	LN			1
 <ul style="list-style-type: none"> <li>• Medio cilindro</li> <li>• Llave normal</li> </ul>	5968T25/3			25	LP	1968		1
	5968T25/4			25	LN			1
	5968T30/3			30	LP			1
	5968T30/4			30	LN			1
	5968T40/3			40	LP			1
5968T40/4			40	LN		1		
 <ul style="list-style-type: none"> <li>• Cilindro doble</li> <li>• Llave de seguridad</li> </ul>	6968/3030/3	30	30	76	LP	1968		1
	6968/3030/4	30	30	76	LN			1
 <ul style="list-style-type: none"> <li>• Medio cilindro</li> <li>• Llave de seguridad</li> </ul>	6968T30/3			30	LP	1968		1
	6968T30/4			30	LN			1



CARACTERÍSTICAS

- Cilindro ovalado
- Cuerpo de latón
- Rotores de latón
- Con levas y vástagos
- 3 llaves

ACCESORIOS OPCIONALES

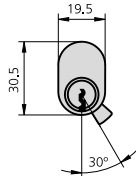

DESCRIPCIÓN	REF.	MEDIDAS			ACABADOS	APLICABLE A CERRADURAS	UDS	
		A	B	C				
 <ul style="list-style-type: none"> <li>• Cilindro doble</li> </ul>	5979/3030/3	30	30	76	LP	1979	1	
	5979/3030/4	30	30	76	LN		1	
 <ul style="list-style-type: none"> <li>• Cilindro doble con pomo</li> </ul>	5979P3030/3	30	30	76	LP	1979P	1	
	5979P3030/4	30	30	76	LN		1	

## VÍAS DE ESCAPE Y CORTAFUEGO

Barra Antipánico de Cierre Lateral con Marcado CE	149
• Serie 5000	149
Barra Antipánico acoplable a cerradura de embutir con Marcado CE	150
• Serie 5500	150
Barra Antipánico de cierre alto-bajo con Marcado CE	151
• Serie 6000	151
Cerradura antipánico palanca deslizante	152
• Series 615, 612 <b>alupanic</b>	152
• Series 615E, 612E <b>alupanic</b>	153
Cerraduras de embutir	154
• Serie 400	154
• Serie 400T	155
Cerradura antipánico palanca deslizante	156
• Serie 410	156
Accesorios	159
• Escudos y Manillas de Acero Inoxidable	159
• Escudos y Manillas en negro	160
• Cilindros y otros accesorios	161

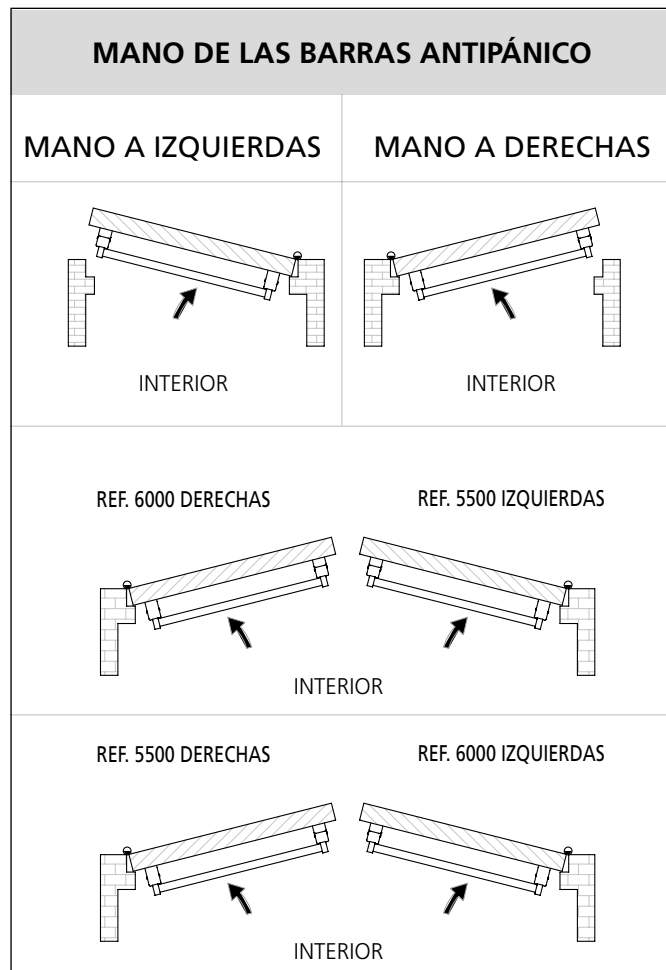
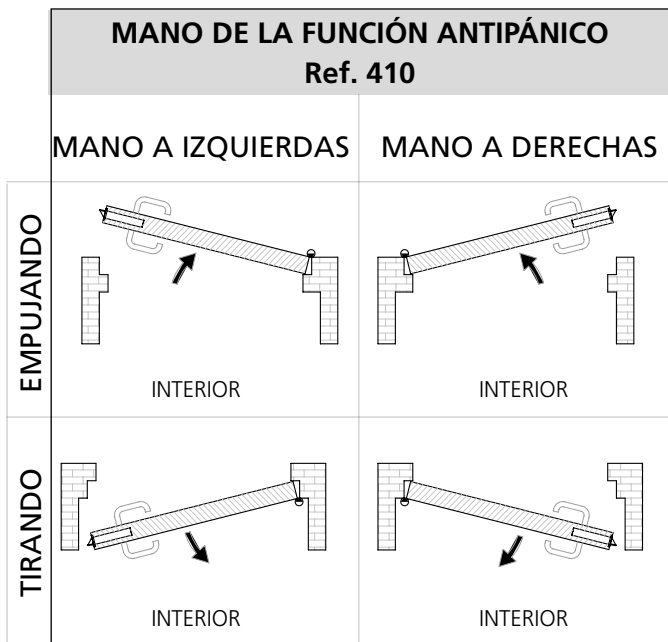



**BARRA ANTIPÁNICO DE CIERRE LATERAL CON MARCADO CE**

**SERIE 5000**

**CARACTERÍSTICAS**

- 1 punto de cierre lateral
- Solución reversible
- Cerradero CE5000
- Certificado CE según norma europea UNE-EN 1125
- Cortafuego

**ACCESORIOS OPCIONALES**

- Barra de apoyo de medidas especiales
- Manilla y escudo en negro M5000, M5001, M5002, M5003
- Manilla y escudo de acero inoxidable CM5006, CM5007, para distintos entre ejes
- Cilindro B5000



ANTIPÁNICO INOX



ANTIPÁNICO NIQUEL MATE



ANTIPÁNICO NEGRO

**DESCRIPCIÓN**

**REF.**

**ACABADOS**

**UDS**

**SOPORTE**

**BARRA**

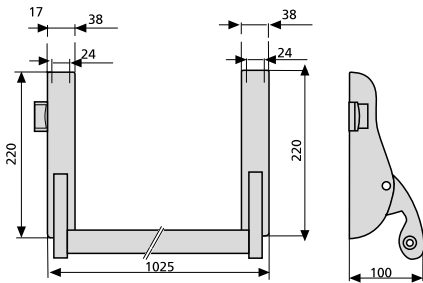

5000/1N	Pintado negro	Pintado rojo	1	5
5000/1NM	Níquel mate	Acero inoxidable Aisi 304L	1	5
5000/6	Acero inoxidable Aisi 304L	Acero inoxidable Aisi 304L	1	5



**BARRA ANTIPÁNICO ACOPLABLE A CERRADURA DE EMBUTIR CON MARCADO CE**

**SERIE 5500**

**CARACTERÍSTICAS**

- Acoplable a cerradura de embutir
- Solución reversible
- Certificado CE según norma europea UNE-EN 1125 con la serie 400T y 400LT, pág. 157
- Cortafuego

**ACCESORIOS OPCIONALES**

- Barra de apoyo de medidas especiales



ANTIPÁNICO INOX



ANTIPÁNICO NÍQUEL MATE



ANTIPÁNICO NEGRO

**DESCRIPCIÓN**

**REF.**

**SOPORTE**

**ACABADOS**

**BARRA**

**UDS**

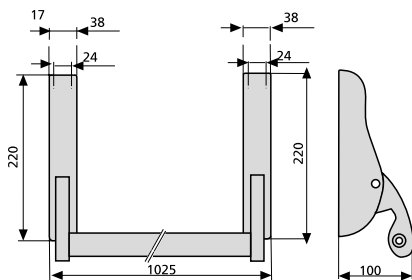

5500/1N	Pintado negro	Pintado rojo	1	5
5500/1NM	Níquel mate	Acero inoxidable Aisi 304L	1	5
5500/6	Acero inoxidable Aisi 304L	Acero inoxidable Aisi 304L	1	5



**BARRA ANTIPÁNICO DE CIERRE ALTO-BAJO CON MARCADO CE**

**SERIE 6000**

**CARACTERÍSTICAS**

- 2 puntos de cierre alto-bajo
- Reversible sin accionamiento exterior
- Cerradores CER5000 y CEB6000
- Certificado CE según norma europea UNE-EN 1125
- Cortafuego

**ACCESORIOS OPCIONALES**

- Barra de apoyo y fallebas de medidas especiales
- Manilla y escudo en negro M5000, M5001, M5002, M5003
- Manilla y escudo de acero inoxidable CM5006, CM5007 para distintos entre ejes
- Cilindro B5000



**DESCRIPCIÓN**

**REF.**

**SOPORTE**

**ACABADOS**

**BARRA**

**FALLEBA**

**UDS**

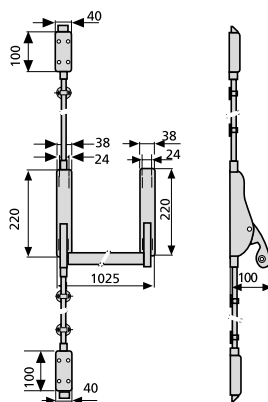

6000D/1N	Pintado negro	Pintado rojo	Pintado negro	1	5
6000I/1N	Pintado negro	Pintado rojo	Pintado negro	1	5
6000D/1NM	Níquel mate	Acero inoxidable Aisi 304L	Acero inoxidable Aisi 304L	1	5
6000I/1NM	Níquel mate	Acero inoxidable Aisi 304L	Acero inoxidable Aisi 304L	1	5
6000D/6	Acero inoxidable Aisi 304L	Acero inoxidable Aisi 304L	Acero inoxidable Aisi 304L	1	5
6000I/6	Acero inoxidable Aisi 304L	Acero inoxidable Aisi 304L	Acero inoxidable Aisi 304L	1	5





CARACTERÍSTICAS

- Cerradura con función antipánico para puertas de aluminio y metálicas
- Sistema antipánico reversible
- Frente inox. de 22 mm
- Picaporte reversible de 11 mm de hierro
- Picaporte regulable, excepto en entrada de 25 mm
- Caja de 15 mm
- Cuadrado de 8 mm
- Operado mediante llave y pomo o manilla desde el exterior
- Tornillo de fijación de cilindro
- Entre ejes 85 mm (615) ó 92 mm (612)
- Ensayado a fuego

ACCESORIOS OPCIONALES

- Gama completa de cerraderos (ver páginas 44 - 51)
- Gama completa de cilindros (ver página 128 - 148)

DESCRIPCIÓN	REF.	MEDIDAS		LEVA	ACABADOS		UDS
		B	A		FRENTE	CANTO	

- Picaporte y palanca
- Cilindro no incluido
- Cerradura con nueca partida

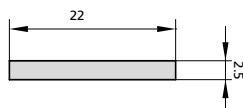

- Opciones de cerradero (ver páginas 44-51)
- Opción de cerradero eléctrico (ver página 52)

615/25/6	22	37	15	Al		1	20
615/30/6	27	42	15	Al		1	20
615/35/6	32	47	15	Al		1	20
612/25/6	22	37	15	Al		1	20
612/30/6	27	42	15	Al		1	20
612/35/6	32	47	15	Al		1	20

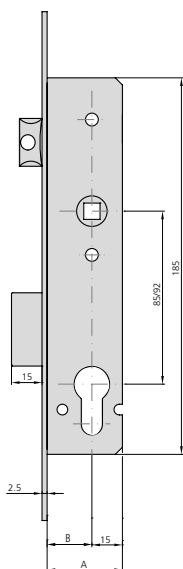

**CERRADURA ANTIPÁNICO PALANCA DESLIZANTE**
**SERIES 615E, 612E**

**CARACTERÍSTICAS**

- Cerradura con función antipánico para puertas de aluminio y metálicas
- Sistema antipánico reversible
- Frente inox de 22 mm
- Picaporte reversible de 11 mm de hierro
- Picaporte regulable, excepto en entrada de 25 mm
- Caja de 15 mm
- Cuadradillo de 8 mm
- **Operado mediante llave y manilla desde el exterior. La llave bloquea o desbloquea la manilla**
- Tornillo de fijación de cilindro
- Entre ejes 85 mm (615E) ó 92 mm (612E)
- Ensayado a fuego

**ACCESORIOS OPCIONALES**

- Gama completa de cerraderos (ver páginas 44 - 51)
- Gama completa de cilindros (ver página 128 - 148)

**DESCRIPCIÓN**
**REF.**
**MEDIDAS**  
**B A**
**LEVA**
**ACABADOS**  
**FRENTE CANTO**
**UDS**

- Picaporte y palanca
- Cilindro no incluido
- Cerradura con nueca partida

- **Opciones de cerradero** (ver páginas 44-51)
- **Opción de cerradero eléctrico** (ver página 52)

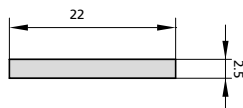

615E/25/6	22	37	15	Al	1	20
615E/30/6	27	42	15	Al	1	20
615E/35/6	32	47	15	Al	1	20
612E/25/6	22	37	15	Al	1	20
612E/30/6	27	42	15	Al	1	20
612E/35/6	32	47	15	Al	1	20

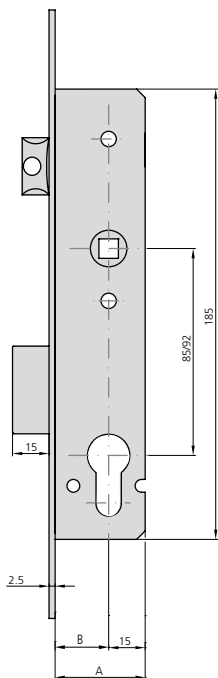

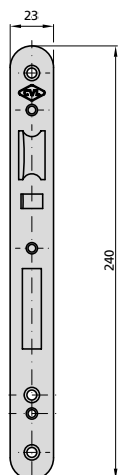



CARACTERÍSTICAS

- Frente en acero inoxidable en canto redondo o cuadrado
- Caja niquelada
- Cuadradillo de 8 mm
- Resbalón de hierro
- Tornillo de fijación de cilindro
- Cerradero de acero inoxidable en canto redondo o cuadrado
- Ensayado a fuego
- Ensayado según UNE EN 12209

ACCESORIOS OPCIONALES

- Gama completa de cilindros (ver página 128 - 148)

DESCRIPCIÓN	REF.	MEDIDAS		LEVA	ACABADOS		UDS	
		B	A		FRENTE	CANTO		
<ul style="list-style-type: none"> <li>• Cerradura con picaporte y palanca rectangular</li> <li>• Cerradura con función antitarjeta</li> </ul>	400L60/6HP	60	90	S. CIL	AI	Red	1	12

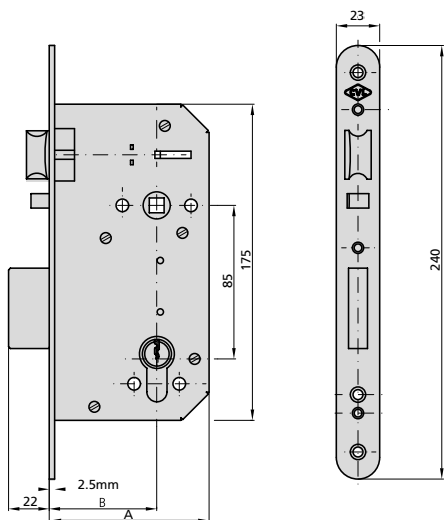

• Cerradura con picaporte y palanca rectangular	400/50/6HP	50	80	S. CIL	AI	Red	1	12
	400/60/6HP	60	90	S. CIL	AI	Red	1	12

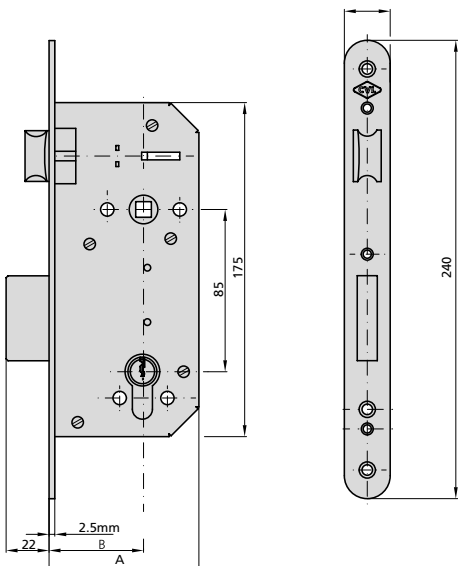

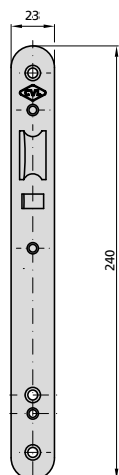
**CERRADURA DE EMBUTIR**
**SERIE 400T**

**CARACTERÍSTICAS**

- Frente en acero inoxidable en canto redondo o cuadrado
- Caja niquelada
- Cuadradillo de 8 mm
- Resbalón de hierro
- Tornillo de fijación de cilindro
- Cerradero de acero inoxidable en canto redondo o cuadrado
- Certificado CE según norma UNE-EN 1125 con la barra antipánico ref. 5500

**ACCESORIOS OPCIONALES**

- Gama completa de cilindros (ver página 128 - 148)

DESCRIPCIÓN	REF.	MEDIDAS		LEVA	ACABADOS		UDS	
		B	A		FRENTE	CANTO		

- Cerradura con sólo picaporte de acero
- Cerradura con función antitarjeta

400LT60/6H	60	90	S. CIL	Al	Red	1	12
------------	----	----	--------	----	-----	---	----

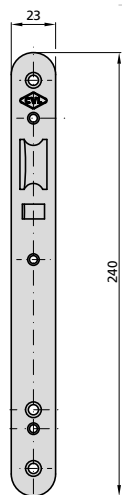
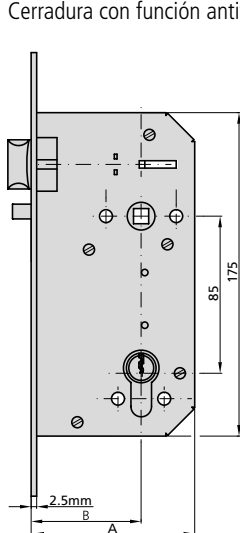

- Cerradura con solo picaporte de acero

400T50/6H	50	80	S. CIL	Al	Red	1	12
400T60/6H	60	90	S. CIL	Al	Red	1	12

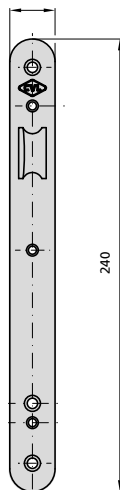
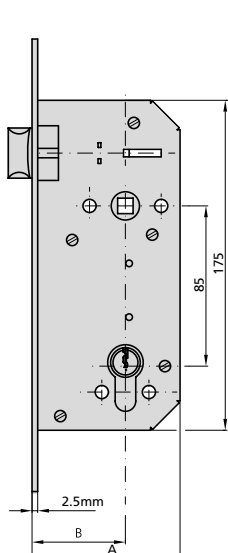





CARACTERÍSTICAS

- Cerradura cortafuego con función antipánico
- Frente de acero inoxidable en canto redondo o cuadrado
- Caja niquelada
- Cuadradillo de 8 mm
- Ensayado según norma EN179 con manilla CM5006I85/6R, CM5006D85/6R (pág. 161)
- Ensayado a fuego
- Cerraderos de acero inoxidable en canto redondo o cuadrado
- Tornillo de fijación de cilindro

ACCESORIOS OPCIONALES

- Gama completa de cilindros (ver página 128 - 148)

DESCRIPCIÓN	REF.	MEDIDAS		LEVA	ACABADOS		UDS	
		B	A		FRENTE	CANTO		
• Cerradura con picaporte y palanca rectangular	410L60D/6HP	60	90	S. CIL	Al	Red	1	12
• Cerradura con función antitarjeta	410L60I/6HP	60	90	S. CIL	Al	Red	1	12
• Cerradura con función antipánico								
• Cerradura con nueca partida								

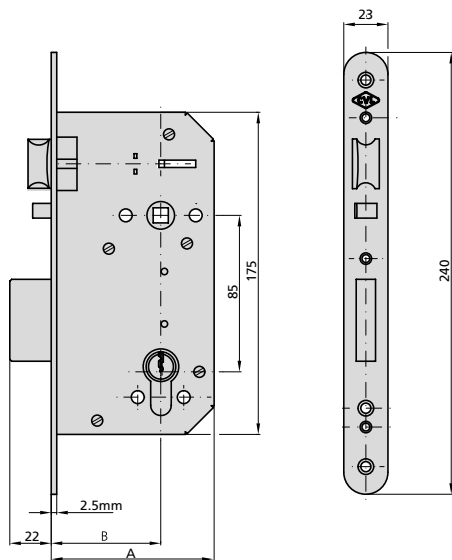

**CERRADURA ANTIPÁNICO PALANCA DESLIZANTE**
**SERIE 410**

DESCRIPCIÓN	REF.	MEDIDAS		LEVA	ACABADOS		UDS	
		B	A		FRENTE	CANTO		
• Cerradura con picaporte y palanca	410/50D/6HP	50	80	S. CIL	Al	Red	1	12
• Cerradura con función antipánico	410/50I/6HP	50	80	S. CIL	Al	Red	1	12
• Cerradura con nueca partida	410/60D/6HP	60	90	S. CIL	Al	Red	1	12
	410/60I/6HP	60	90	S. CIL	Al	Red	1	12

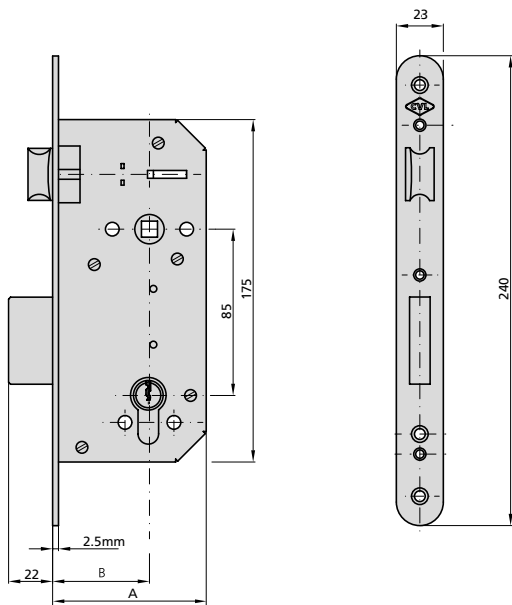

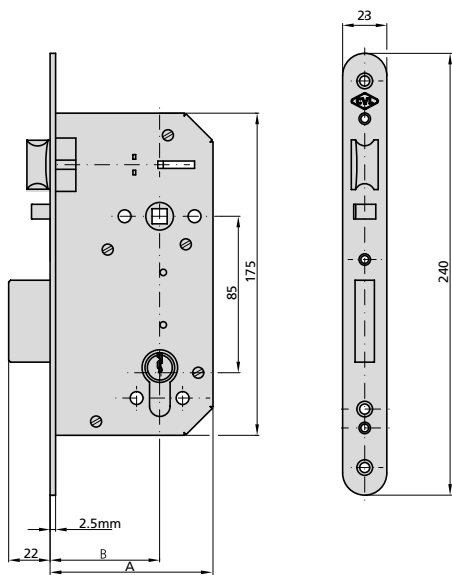

- Cerradura con picaporte y palanca rectangular
- Cerradura con función antitarjeta
- Cerradura con función antipánico
- Cerradura con nueca pasante

410L60/6HP	60	90	S. CIL	Al	Red	1	12
------------	----	----	--------	----	-----	---	----



# CERRADURA ANTIPÁNICO PALANCA DESLIZANTE

# SERIE 410

DESCRIPCIÓN	REF.	MEDIDAS		LEVA	ACABADOS		UDS	
		B	A		FRENTE	CANTO		
• Cerradura con picaporte y palanca	410/50/6HP	50	80	S. CIL	Al	Red	1	12
• Cerradura con función antipánico	410/60/6HP	60	90	S. CIL	Al	Red	1	12
• Cerradura con nueca pasante								

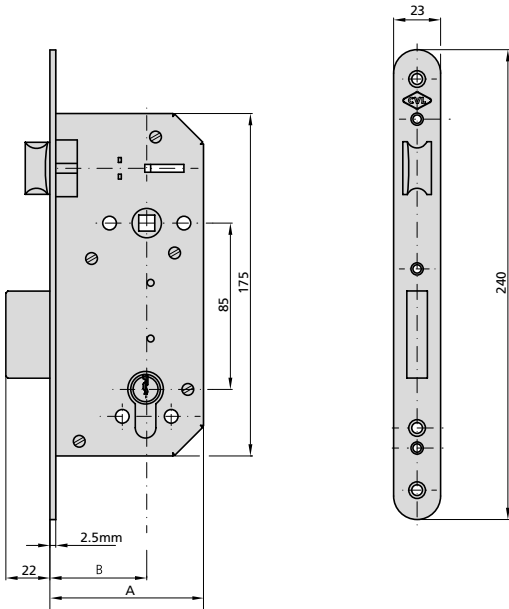

**ACCESORIOS**
**ESCUDOS Y MANILLAS DE ACERO INOXIDABLE**

**CARACTERÍSTICAS**

- Manillas de acero inoxidable

DESCRIPCIÓN	REF.	ACABADO	CANTO	UDS
<ul style="list-style-type: none"> <li>• Escudo con manilla y bocallave cilindro</li> <li>• Entre ejes 55 mm</li> <li>• Cilindro no incluido</li> </ul>	CM5006I55/6R CM5006D55/6R	AI AI	Red Red	1 1
<ul style="list-style-type: none"> <li>• Escudo con manilla y bocallave cilindro</li> <li>• Entre ejes 72 mm</li> <li>• Cilindro no incluido</li> </ul>	CM5006I72/6R CM5006D72/6R	AI AI	Red Red	1 1
<ul style="list-style-type: none"> <li>• Escudo con manilla y bocallave cilindro</li> <li>• Entre ejes 85 mm</li> <li>• Cilindro no incluido</li> </ul>	CM5006I85/6R CM5006D85/6R	AI AI	Red Red	1 1
<ul style="list-style-type: none"> <li>• Escudo con manilla</li> </ul>	CM5007I/6R CM5007D/6R	AI AI	Red Red	1 1



ACCESORIOS

ESCUDOS Y MANILLAS EN NEGRO



CARACTERÍSTICAS

- Manillas pintadas en negro

DESCRIPCIÓN	REF.	ACABADO	CANTO	UDS
<ul style="list-style-type: none"> <li>• Escudo con manilla y bocallave cilindro</li> <li>• Entre ejes 55 mm</li> <li>• Incluye cilindro B5000</li> </ul>	M5000D/1N M5000I/1N	Negro Negro	Cua Cua	1 1
<ul style="list-style-type: none"> <li>• Escudo con manilla</li> </ul>	M5001D/1N M5001I/1N	Negro Negro	Cua Cua	1 1
<ul style="list-style-type: none"> <li>• Escudo con bocallave cilindro</li> <li>• Entre ejes 55 mm</li> <li>• Incluye cilindro B5000</li> </ul>	M5002/1N	Negro	Cua	1
<ul style="list-style-type: none"> <li>• Escudo ciego</li> </ul>	M5003/1N	Negro	Cua	1
<ul style="list-style-type: none"> <li>• Escudo con tirador y bocallave</li> <li>• Incluye cilindro B5000</li> </ul>	M5004/1N	Negro	Cua	1

DESCRIPCIÓN	REF.	ACABADO	UDS
• Cilindro para barra antipánico	B5000	CL	1
	B5000/4	CN	1

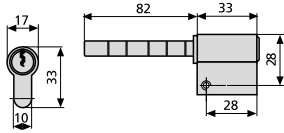

DESCRIPCIÓN	REF.	ACABADO
• Barra de apoyo Ø25*1000 mm	BAR5000/6	Al
• Barra de apoyo Ø25*1500 mm	BAR5000/6E	Al
• Barra de apoyo Ø25*1000 mm	BAR5000/1R	HE rojo
• Barra de apoyo Ø25*1500 mm	BAR5000/1RE	HE rojo
• Barra de apoyo Ø25*2000 mm	BAR5000/1RE2	HE rojo
• Tubo falleba Ø12*1000 mm	TUF6000/6	Al
• Tubo falleba Ø12*1500 mm	TUF6000/6E	Al
• Tubo falleba Ø12*1000 mm	TUF6000/1N	HE negro
• Tubo falleba Ø12*1500	TUF6000/1NE	HE negro
• Tubo falleba Ø12*2000	TUF6000/1NE2	HE negro
• Cerradero lateral	CE5000/1N	HE negro
• Cerradero lateral	CE5000/6	Al
• Cerradero bajo	CEB6000/1N	Acero microfundido negro
• Cerradero bajo	CEB6000	Acero microfundido



## CONTROL DE ACCESOS



Dispositivos de apertura

164

## DISPOSITIVOS DE APERTURA

	DESCRIPCIÓN	REF.
	<ul style="list-style-type: none"> <li>• Kit control de acceso de apertura con tarjeta de proximidad.</li> <li>• Listo para utilizar:               <ul style="list-style-type: none"> <li>- Incluye tarjetas Mifare programado y borrado.</li> <li>- Sin necesidad de software.</li> </ul> </li> <li>• Incluye cable lector.</li> <li>• Posibilidades amplias de amaestramiento.</li> </ul>	KLECP1
	Llavero programable	LLAVERO1
	Pegatina o Tag programable	TAG1
	Tarjeta programable Mifare	TARJ1
	Recargo configuración Tarjeta Mifare	
	<ul style="list-style-type: none"> <li>• Lector de huella autónomo mediante tecnología bluetooth.</li> <li>• Grabación sencilla de huellas a través de app gratuita.</li> <li>• Posibilidad de hasta 99 huellas.</li> <li>• Incluye cableado para instalación.</li> <li>• No incluye pasacables.</li> <li>• Tiene que llevar pasacables.</li> </ul>	KLECH1/6
©ekey biometric systems		
	<ul style="list-style-type: none"> <li>• Lector de teclado para apertura de puerta.</li> <li>• Panel táctil de cristal negro.</li> <li>• Posibilidad de programar hasta 99 secuencias numéricas de 4 a 8 dígitos.</li> <li>• Incluye cableado para instalación.</li> <li>• No incluye pasacables.</li> <li>• Tiene que llevar pasacables.</li> </ul>	KLECT1/N
©ekey biometric systems		
	<ul style="list-style-type: none"> <li>• Pasacable oculto en la hoja o en el marco.</li> <li>• Diámetro interior 9,4mm.</li> <li>• Diámetro exterior 11,8mm.</li> <li>• Longitud de tubo 290mm.</li> </ul>	PASCABO1
	<ul style="list-style-type: none"> <li>• Pasacables de sobrepone para pasar electricidad del marco a la hoja.</li> </ul>	PASCABS1
	<ul style="list-style-type: none"> <li>• Fuente de alimentación 12VDC 3A 230V AC/36VA.</li> </ul>	FA12VDC3A1

**OTROS PRECIOS**
**LLAVE SERRETA**
**DESCRIPCIÓN**

Cilindro largo especial

Maestramiento. 1 lado

Maestramiento. 2 lados

Gran Maestra. Un lado

Gran Maestra. Dos lados

Cilindro con llaves iguales

Cilindro con llaves según muestra

Llave suplementaria (125)

Llave sin mecanizar (125)

Llave mecanizada según muestra (125)

**OTROS PRECIOS**
**LLAVE SEGURIDAD**
**DESCRIPCIÓN**

Maestramiento. 1 lado

Maestramiento. 2 lados

Gran Maestra. Un lado

Gran Maestra. Dos lados

Cilindro con llaves iguales

Cilindro con llaves según muestra

Llave suplementaria

Llave sin mecanizar

Llave mecanizada según muestra

**OTROS PRECIOS**
**OTROS**

Reductor metálico

Rgo. frente 2300 mm

Rgo. frente 1500 mm



Sistemas Valle Leniz S.L.U. • Pol. Arbi Zelai • Apdo 6, 20550 • Aretxabaleta • Gipuzkoa (Spain)  
Tel: 943 79 10 16 • Fax: 943 79 25 46 • E-mail: cvl@cvl.es • Web: www.cvl.es

